



Vormatic Digital Display & Kiosk

Product Catalog

ABOUT US



WHO WE ARE

Vormatic is one High-Tech Company, whose mission is to drive customer growth, innovation and productivity, to manufacture and supply all kinds of digital signage displays with the highest quality standards and the fastest delivery at the most competitive price, Vormatic always works on to create & introduce new technologies by using finest materials, intelligent designs and innovative applications.

WHAT WE DO

We are a premier digital signage manufacturer, have served a range of clients, industries and end users all over the world. Our products include:

- Application: Indoor/Outdoor
- Type: Wall mounted/Freestanding
- Size: 10"/12"/15"/19"/22"/24"/27"/32"/43"/49"/55"/65"/ 75"/86"/98"
- Ultra-stretch Size: 14.9"/19.1"/23.1"/28.8"/38"/57.2"
- Function: Android System/Windows System/Plug & Play /LCD Monitor
- Extended: Infrared Touch/PCAP Touch/High Brightness/Printer/Camera

WHY CHOOSE US



DESIGN

We collect and absorb advanced and useful information from market and clients. We have strong and rich experience R&D engineers to design and improve our mechanical and electronic layout depending on the information.



CUSTOMIZATION

We have more than 200 OEM/ODM clients all over the world, Specialty, Flexibility and Diversity are our features, we modify, build and design according to customers' needs and projects.



FAST DELIVERY

We have our own hardware factory that can control the metal housing design, production and quality process, also prepare some champion products in stock according to the marketing information.



QUALIFICATION

We have strict IQC/QC/QA Process.

****100% QC Test for all coming material before production.

****100% QC Test for all LCD Panels with A++ Grade before purchase.

****100% 24-48 hours aging test for all finished products before shipment.

All products are with CE/FCC/ROHS Certificates, we also have all kinds of patent certifications.



AFTER-SALE SERVICE

We provide excellent after-sale service and maintenance. Our team make sure that every project is maintained, checked and tested well. We also provide fast response within 12 hours.



RELIABLE PACKAGE

We know LCD panel is damaged easily during transportation, we have very strong package (wooden case/flight case) for the shipment to avoid the loss and damage caused by shipment.

Exquisite Appearance Design

PRODUCT DETAILS

WE GUARANTEE 100% CUSTOMER SATISFACTION



Exquisite Interior Design

NEW DESIGN

EASY MAINTENANCE EVEN FOR END USER

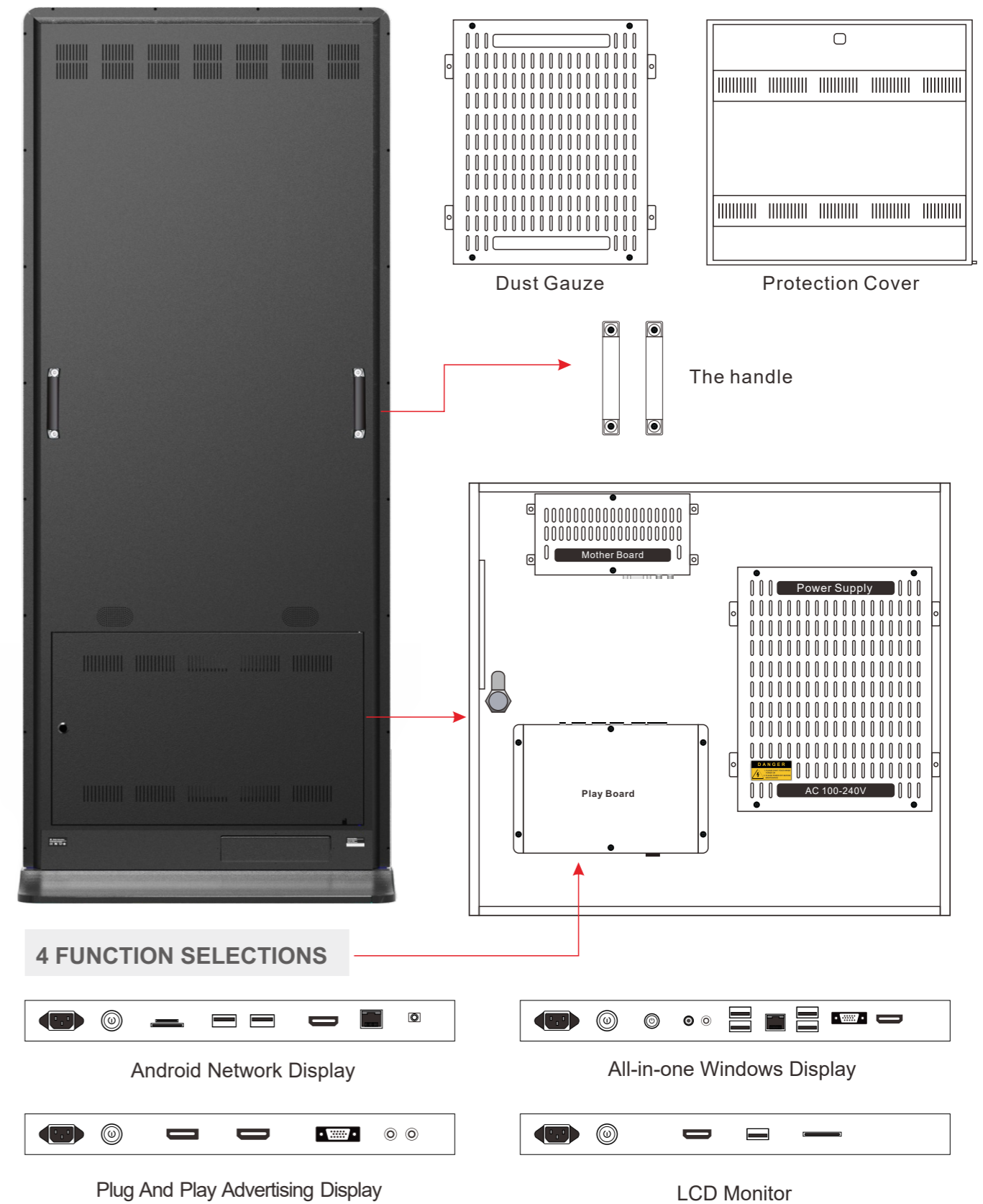

USE ENVIRONMENT

With the development of business and consumer environment, the demand for advertisement is becoming more and more big. Digital, network, and information of the multimedia advertising machine have become a major bright spot in the advertising media market. With the acceleration of information transmission and the popularization of the network, the advertising machine has been difficult to meet the needs of information dissemination. Advertising machine confidential replacement in advertising must be CF card or DVD disk, not only caused a lot of human waste, but it is difficult to provide a particular audience with multimedia information timely and accurately. Network of multimedia advertising machine is highly favored due to the leading edge of the technology in the hotels, supermarkets, buildings and other high income areas of advertising.



Store



Airport Hall



Fashion Shop



Conference Room



Shopping Mall



Bus Digital Signage



Reception



Outdoor



Building Hall



Check Out



CONTENTS

CONTENTS

One-stop Digital Signage Solutions

- P01
LB Series
Iphone Design Freestanding Digital Signage Display
▶
- CB/JB Series P05
Interactive Table-design Kiosk
▶
- P09
F Series
Vehicle-mounted Digital Signage Display
▶
- J Series P13
Iphone Design Wall Mounting Display
▶
- P17
C/OP Series
Close Frame/Open Frame Wall mount Design
▶
- K Series P23
Stretched Display
▶
- P27
W Series
LCD Video Wall Display
▶
- H Series P31
Semi-outdoor Display
▶
- P39
OD Series
Outdoor Display with IP65 Grade
▶
- JL Series P51
Desktop Interactive Display
▶
- P55
D Series
Ultra Slim Free Standing LCD Monitor
▶
- OEM/ODM Series P63
Customized Products
▶
- P75
Media Player Boxes
▶
- Case Show P79

▶
- P83
Exhibition Show
▶
- Quality Control / Package P85

▶
- P89
Certificates / Office Environment
▶



Optional size: 21.5"/32"/43"/49"/55"/65"/75"

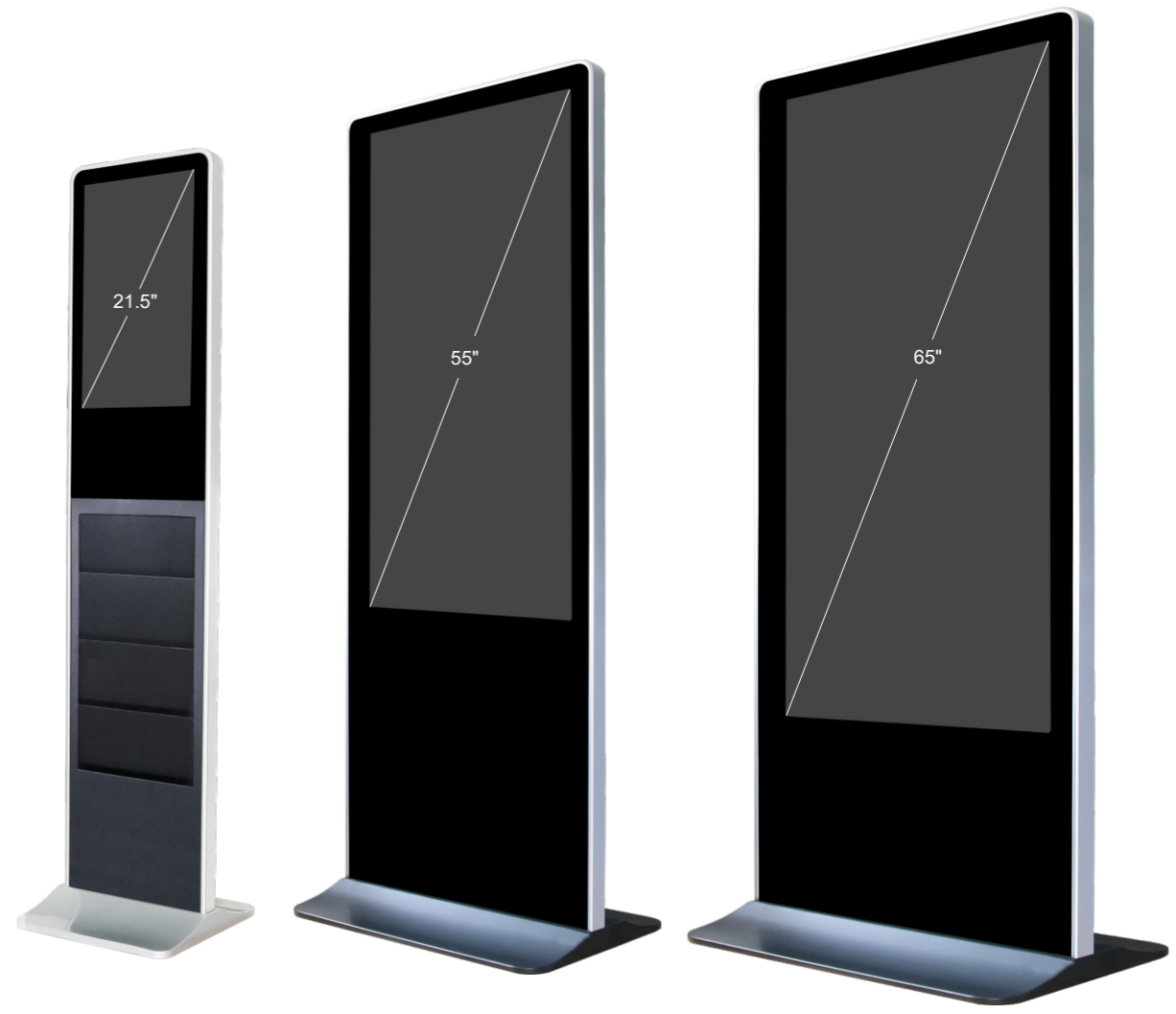

LB SERIES
 Iphone Design Freestanding Digital Signage Display



- Application**
- Security
 - Transportation
 - ATM Machine
 - Medical Equipment
 - Gaming Machine
 - Networking POS
 - General Application

- Design/Material**
- 22"-75" Optional
 - Tempered Glass Protection
 - Aluminum Frame With Silver Color
 - 40mm Thickness Design
 - Infrared Touch/Capacitive Touch Optional



AZ Android Network Display

- a. Android 7.1/8.1/9.0 operating system optional
- b. RK 3288 / RK 3399 optional
- c. 2GB/4GB RAM (DDR3) optional
- d. 8GB/16GB/32GB/64GB flash optional
- e. 4G(optional)/WLAN/WiFi network connection
- f. 802.11 B/G/N Internal WiFi
- g. Portrait/landscape display mode
- h. 1080P display output
- i. Remote management software (CMS) optional

PC All-in-one Windows Display

- a. CPU: Intel® Celeron® Processor J1900 /Intel® Core® Processor I3/I5/I7
- b. Chipset: Intel Bay trail SOC /Intel® H310 Chipset
- c. System memory: 4GB/8GB RAM, 120GB/240GB SSD
- d. Input connectors: VGA/HDMI/USB/RJ45/Audio
- e. Operating system: Windows 7/8/10, Linux
- f. Preinstall Intel OS service optional



C Plug And Play Advertising Display

- a. Support picture, music and video to 1080P
- b. Support SD/HDMI/USB inputs
- c. Support SD card plug and play automatically
- d. USB update function: update documents by USB drive to SD card
- e. Support connecting with media player box/PC by HDMI input
- f. Playlist function: auto play the designated file at the specific date
- g. Timer function: 5 groups timers to turn on/off at the designated time
- h. Slideshow functions to play music and pictures at the same time
- i. Portrait/landscape display mode
- j. Scrolling text with different color and effect

M LCD Monitor

- a. Professional design for 7-24 hours operation
- b. DP/HDMI/VGA inputs
- c. Full HD resolution supported
- d. Support connecting with media player box/PC by HDMI input

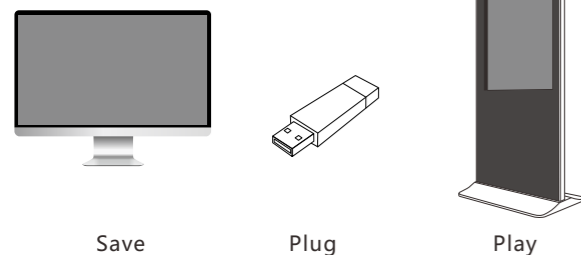

PANEL SPECIFICATIONS

Model No	RCS-220LB	RCS-320LB	RCS-430LB	RCS-490LB	RCS-550LB	RCS-650LB
Panel Model	21.5inch TFT LED	32inch TFT LED	43inch TFT LED	49inch TFT LCD	55inch TFT LED	65 inch TFT LED
Max Resolution	1920x1080	1920x1080	1920x1080	1920x1080	1920x1080	3840x2160
Aspect Ratio	16:09	16:09	16:09	16:09	16:09	16:09
Pixel Pitch	0.24795x0.24795	0.36375x0.36375	0.4903x0.4903	0.53025*0.53025	0.63x0.63	0.372x0.372
Viewing Angle	89/89/89/89	89/89/89/89	89/89/89/89	89/89/89/89	89/89/89/89	89/89/89/89
Contrast Ratio	1000:1	1400:1	1200:1	1000:1	1400:1	1400:1
Brightness	250cd/m ²	500cd/m ²	500cd/m ²	500cd/m ²	500cd/m ²	500cd/m ²
Response Time	14ms	6.5ms	26ms	12ms	6ms	13ms
Display Area (mm)	476.064x267.786mm	698.4x392.85	941.184x592.416	1073.78x604	1209.6x680.4	1428.48x803.52
Panel Size(mm)	495.6x292.2x10.7mm	727.4x429x227	973x565.8x29	1096.2x632.5x29	1244.6x720.9x27	1459.2x830x16
Screen Weight	2Kg	4.8Kg	11Kg	18Kg	17.5Kg	22.7Kg
Lamp Type	WLED	WLED	WLED	WLED	WLED	WLED
Machine Weight	21.3KG	45.3KG	53KG	86.7KG	95.2KG	98KG
Dimensions(mm)	1562.5x40x350	1734x65x511	1784x65x639	1834x65x714	1884x65x790	1940x69x1000
Speaker Type	10Wx2pcs	10Wx2pcs	10Wx2pcs	10Wx2pcs	10Wx2pcs	10Wx2pcs
Consumption	25 W	40 W	70 W	93 W	115 W	230 W
Power Input	AC100-240V	AC100-240V	AC100-240V	AC100-240V	AC100-240V	AC100-240V
Media Players	Android System / Windows System / Plug&play System / Monitor					
Mechanical	Cabinet Material	Surface: Tempered glass Body: Metal case; Side Frame: Aluminum; Base: Metal				
Extended function	Touch	IR Touch / Capacitive (PCAP) Touch				
	Motion Sensor	Optional				
	High Brightness	Normal/500nits/1000nits/1500nits/2000nits optional				
Accessories	Remote Control, Power supply, User manual, Keys, Tools and Screws					

LB Series case





CB/JB SERIES

Interactive Table-design Kiosk



Optional size: 21.5"/24"/32"/43"/49"/55"/65"

CB Series



Optional size: 32"/43"/49"/55"/65"

CI/SS Series



Optional size: 32"/43"/49"/55"/65"

JB Series



Application

- Security
- Transportation
- ATM
- Medical Equipment
- Gaming Machine
- Networking POS
- General Application

Design/Material

- CB/JB Series:**
- 22"-65" Optional
 - Screen And Stand Could Be Removable
 - Metal Case Material With White Painting/ Aluminum Frame With Silver Color
 - Tempered Glass Protection

AZ Android Network Display

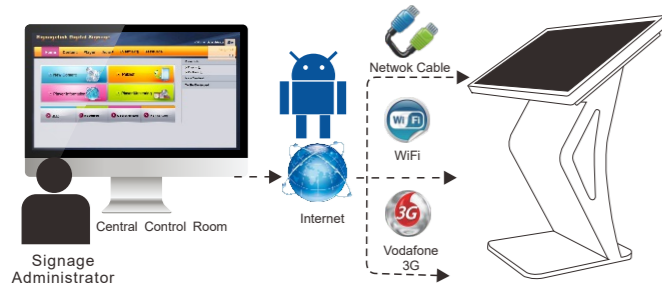

- a. Android 7.1/8.1/9.0 operating system optional
- b. RK 3288 / RK 3399 optional
- c. 2GB/4GB RAM (DDR3) optional
- d. 8GB/16GB/32GB/64GB flash optional
- e. 4G(optional)/WLAN/WiFi network connection
- f. 802.11 B/G/N Internal WiFi
- g. Portrait/landscape display mode
- h. 1080P display output
- i. Remote management software (CMS) optional

PC All-in-one Windows Display



- a. CPU: Intel® Celeron® Processor J1900 /Intel® Core® Processor I3/I5/I7
- b. Chipset: Intel Bay trail SOC /Intel® H310 Chipset
- c. System memory: 4GB/8GB RAM, 120GB/240GB SSD
- d. Input connectors: VGA/HDMI/USB/RJ45/Audio
- e. Operating system: Windows 7/8/10, Linux
- f. Preinstall Intel OS service optional

C Plug And Play Advertising Display

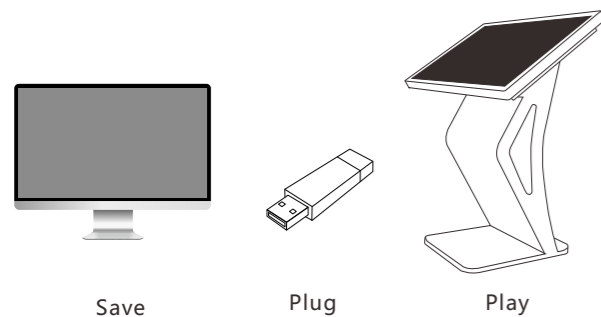

- a. Support picture, music and video to 1080P
- b. Support SD/HDMI/USB inputs
- c. Support SD card plug and play automatically
- d. USB update function: update documents by USB drive to SD card
- e. Support connecting with media player box/PC by HDMI input
- f. Playlist function: auto play the designated file at the specific date
- g. Timer function: 5 groups timers to turn on/off at the designated time
- h. Slideshow functions to play music and pictures at the same time
- i. Portrait/landscape display mode
- j. Scrolling text with different color and effect

M LCD Monitor



- a. Professional design for 7-24 hours operation
- b. DP/HDMI/VGA inputs
- c. Full HD resolution supported
- d. Support connecting with media player box/PC by HDMI input

PANEL SPECIFICATIONS

Model No	RCS-220CB	RCS-240CB	RCS-320CB	RCS-430CB	RCS-490CB	RCS-550CB
	RCS-220JB	RCS-240JB	RCS-320JB	RCS-430JB	RCS-490JB	RCS-550JB
Panel Model	21.5inch TFT LED	23.6inch TFT LCD	32inch TFT LED	43inch TFT LED	49inch TFT LCD	55inch TFT LED
Max Resolution	1920x1080	1920x1080	1920x1080	1920x1080	1920x1080	1920x1080
Aspect Ratio	16:09	16:9	16:09	16:09	16:09	16:09
Pixel Pitch	0.24795x0.24795	0.2715x0.2715	0.36375x0.36375	0.4903x0.4903	0.53025x0.53025	0.63x0.63
Viewing Angle	89/89/89/89	89/89/89/89	89/89/89/89	89/89/89/89	89/89/89/89	89/89/89/89
Contrast Ratio	1000:1	3000:1	1400:1	1200:1	1000:1	1400:1
Brightness	250cd/m ²	250cd/m ²	500cd/m ²	500cd/m ²	500cd/m ²	500cd/m ²
Response Time	14ms	10ms	6.5ms	26ms	12ms	6ms
Display Area (mm)	476.064x267.786mm	521.28x293.22	698.4x392.85	941.184x592.416	1073.78x604	1209.6x680.4
Panel Size(mm)	495.6x292.2x10.7mm	544.8x320.5x11.5	727.4x429x227	973x565.8x29	1096.2x632.5x29	1244.6x720.9x27
Screen Weight	2Kg	2.3Kg	4.8Kg	11Kg	18Kg	17.5Kg
Lamp Type	WLED	WLED	WLED	WLED	WLED	WLED
Machine Weight	7KG	10.3KG	17.2KG	30.4KG	36.5KG	58KG
Dimensions(mm)	550x65x340	710x55x475	775x70x470	1050x97x630	1150x95x675	1293x79x764
Speaker Type	10Wx2pcs	10Wx2pcs	10Wx2pcs	10Wx2pcs	10Wx2pcs	10Wx2pcs
Consumption	25 W	31 W	40 W	70 W	93 W	115 W
Power Input	AC100-240V	AC100-240V	AC100-240V	AC100-240V	AC100-240V	AC100-240V
Media Players	Android System / Windows System / Plug&play System / Monitor					
Mechanical	Cabinet Material	Body: Metal case; Base: Metal				
Extended function	Touch	IR Touch / Capacitive (PCAP) Touch				
	Motion Sensor	Optional				
	High Brightness	Normal/500nits/1000nits/1500nits/2000nits optional				
Accessories	Remote Control, Power supply, User manual, Keys, Tools and Screws					

CB Series case





Handrail mount

Optional size: 10.1"/12.1"/15.6"/19"/22"/32"

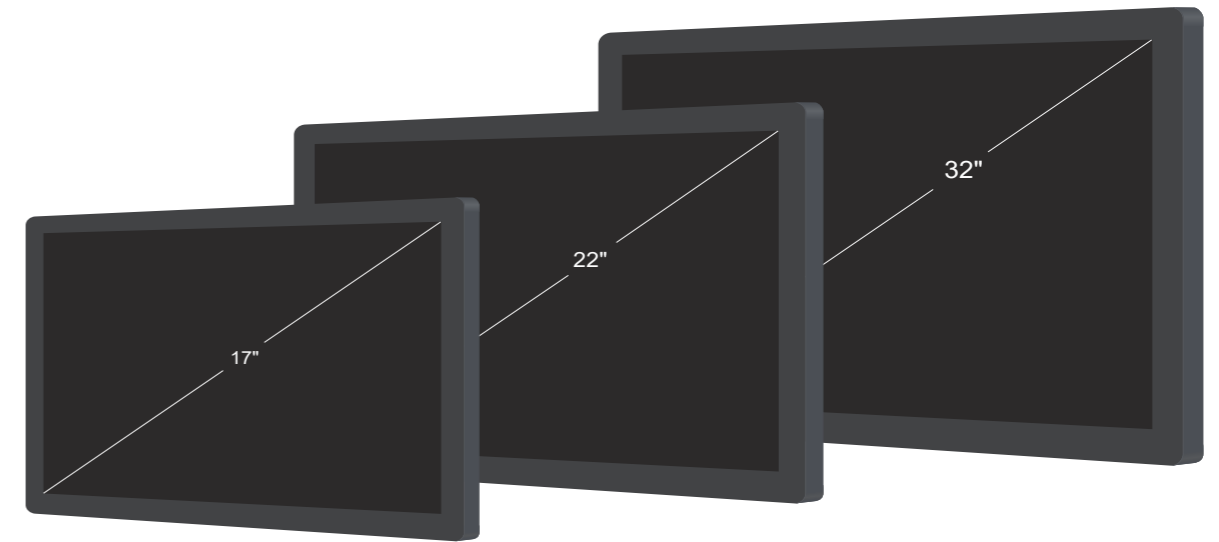

Ceiling mount

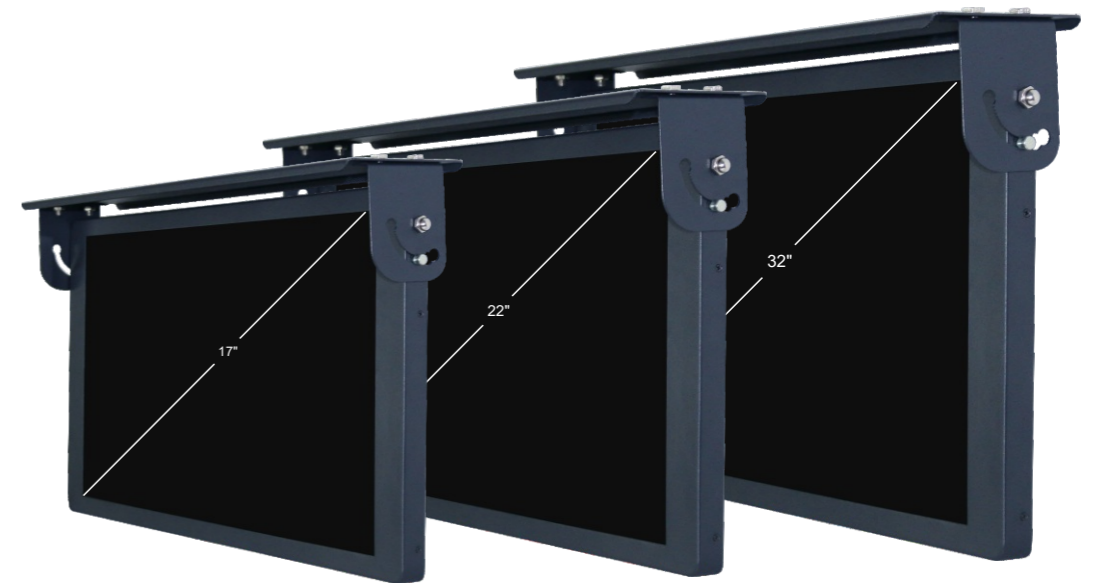

F SERIES
Vehicle-mounted Digital Signage Display



Application

- Ceiling Mount Bus/Train/Taxi/Metro/Car Display
- Handrail Mount Bus/Train/Taxi/Metro/Car Display
- Network Transit TV
- In-Vehicles And Transportation

Design/Material

- 10"-32" optional
- Ceiling Mount/Handrail Mount optional
- 9-36V power connection
- Shock-proof Function
- WLAN/WIFI/3G/4G/GPS/Camera, optional
- Tempered glass front of the screen
- Extended playing 0-999 minutes

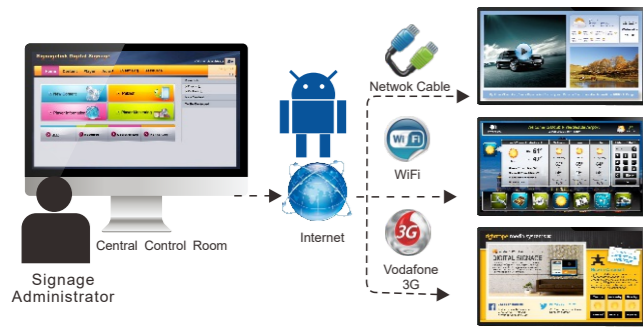

AZ Android Network Display

- a. Android 7.1/8.1/9.0 operating system optional
- b. RK 3288 / RK 3399 optional
- c. 2GB/4GB RAM (DDR3) optional
- d. 8GB/16GB/32GB/64GB flash optional
- e. 4G(optional)/WLAN/WiFi network connection
- f. 802.11 B/G/N Internal WiFi
- g. Portrait/landscape display mode
- h. 1080P display output
- i. Remote management software (CMS) optional

PC All-in-one Windows Display

- a. CPU: Intel® Celeron® Processor J1900 /Intel® Core® Processor I3/I5/I7
- b. Chipset: Intel Bay trail SOC /Intel® H310 Chipset
- c. System memory: 4GB/8GB RAM, 120GB/240GB SSD
- d. Input connectors: VGA/HDMI/USB/RJ45/Audio
- e. Operating system: Windows 7/8/10, Linux
- f. Preinstall Intel OS service optional



C Plug And Play Advertising Display

- a. Support picture, music and video to 1080P
- b. Support SD/HDMI/USB inputs
- c. Support SD card plug and play automatically
- d. USB update function: update documents by USB drive to SD card
- e. Support connecting with media player box/PC by HDMI input
- f. Playlist function: auto play the designated file at the specific date
- g. Timer function: 5 groups timers to turn on/off at the designated time
- h. Slideshow functions to play music and pictures at the same time
- i. Portrait/landscape display mode
- j. Scrolling text with different color and effect

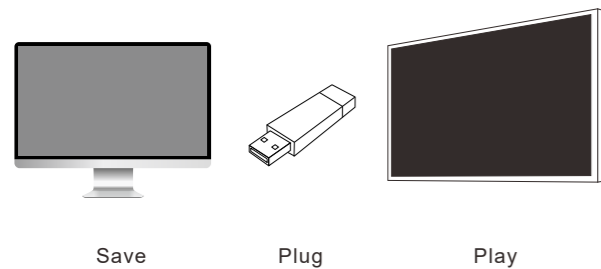

M LCD Monitor

- a. Professional design for 7-24 hours operation
- b. DP/HDMI/VGA inputs
- c. Full HD resolution supported
- d. Support connecting with media player box/PC by HDMI input



PANEL SPECIFICATIONS

Model No	RCS-101F	RCS-121F	RCS-151F	RCS-191F	RCS-220F	RCS-320F
Panel Model	10.1inch TFT LED	12.1inch TFT LED	15.6inch TFT LCD	19inch TFT LCD	21.5inch TFT LED	32inch TFT LED
Max Resolution	1280x800	1280x800(WXGA)	1920x1080	1440x900	1920x1080	1920x1080
Aspect Ratio	16:10	16:10	16:09	16:10	16:09	16:09
Pixel Pitch	0.1659x0.1659	0.204x0.204	0.17925x0.17925	0.2835x0.2835	0.24795x0.24795	0.36375x0.36375
Viewing Angle	85/85/85/85	80/80/65/80	85/85/85/85	85/85/80/80	89/89/89/89	89/89/89/89
Contrast Ratio	1300:1	800:1	700:1	1000:1	1000:1	1400:1
Brightness	350cd/m ²	400cd/m ²	300cd/m ²	300cd/m ²	250cd/m ²	500cd/m ²
Response Time	25ms	35ms	25ms	5ms	14ms	6.5ms
Display Area (mm)	216.96x135.60	261.12x163.2	344.16x193.59	408.24x255.15	476.064x267.786mm	698.4x392.85
Panel Size(mm)	241.86x161.6x5.2	278x184x8.6	359.5x223.8x3.2	428x278x11	495.6x292.2x10.7mm	727.4x429x227
Screen Weight	180g	550g	1.2kg	1.57Kg	2Kg	4.8Kg
Lamp Type	WLED	WLED	WLED	WLED	WLED	WLED
Machine Weight	3.7 KG	4.0KG	4.2 KG	4.7 KG	5.5 KG	15.5 KG
Dimensions(mm)	315x230x80	330x235x50	405x265x60	485x315x60	560x340x55	790x460x70
Speaker Type	5Wx2pcs	5Wx2pcs	5Wx2pcs	5Wx2pcs	5Wx2pcs	5Wx2pcs
Consumption	12 W	15 W	16 W	22 W	25 W	46 W
Power Input	DC 9-36V	DC 9-36V	DC 9-36V	DC 9-36V	DC 9-36V	DC 9-36V
Media Players	Android System / Windows System / Plug&play System / Monitor					
Mechanical	Cabinet Material	Body: Metal case; Side Frame: Aluminum; Cabinet material: Metal				
Mounting Bracket	Handrail mounting / Ceiling mounting					
Extended Function	GPS Function					
	Camera Function					
	3G Function					
Accessories	Remote Control, User manual, Keys, Tools and Screws					

F Series case

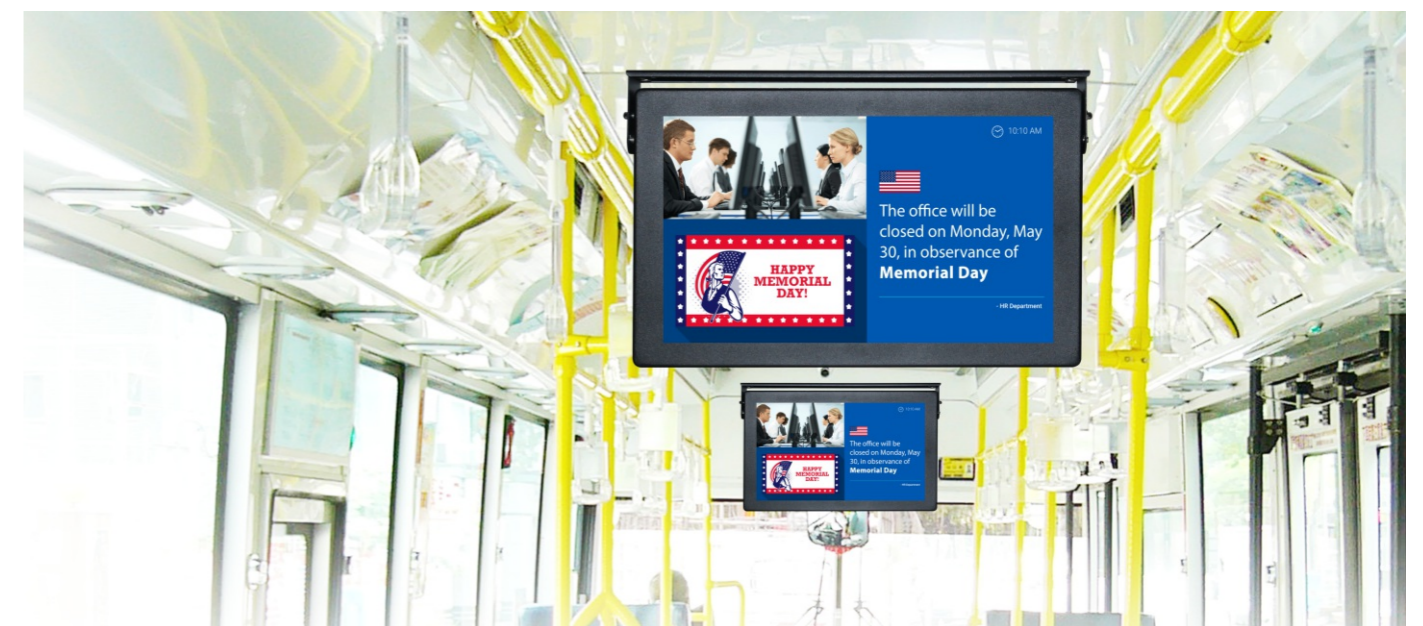



J SERIES

iPhone Design Wall Mounting Display



Optional size: 10.1"/19"/22"/32"/43"/49"/55"/65"

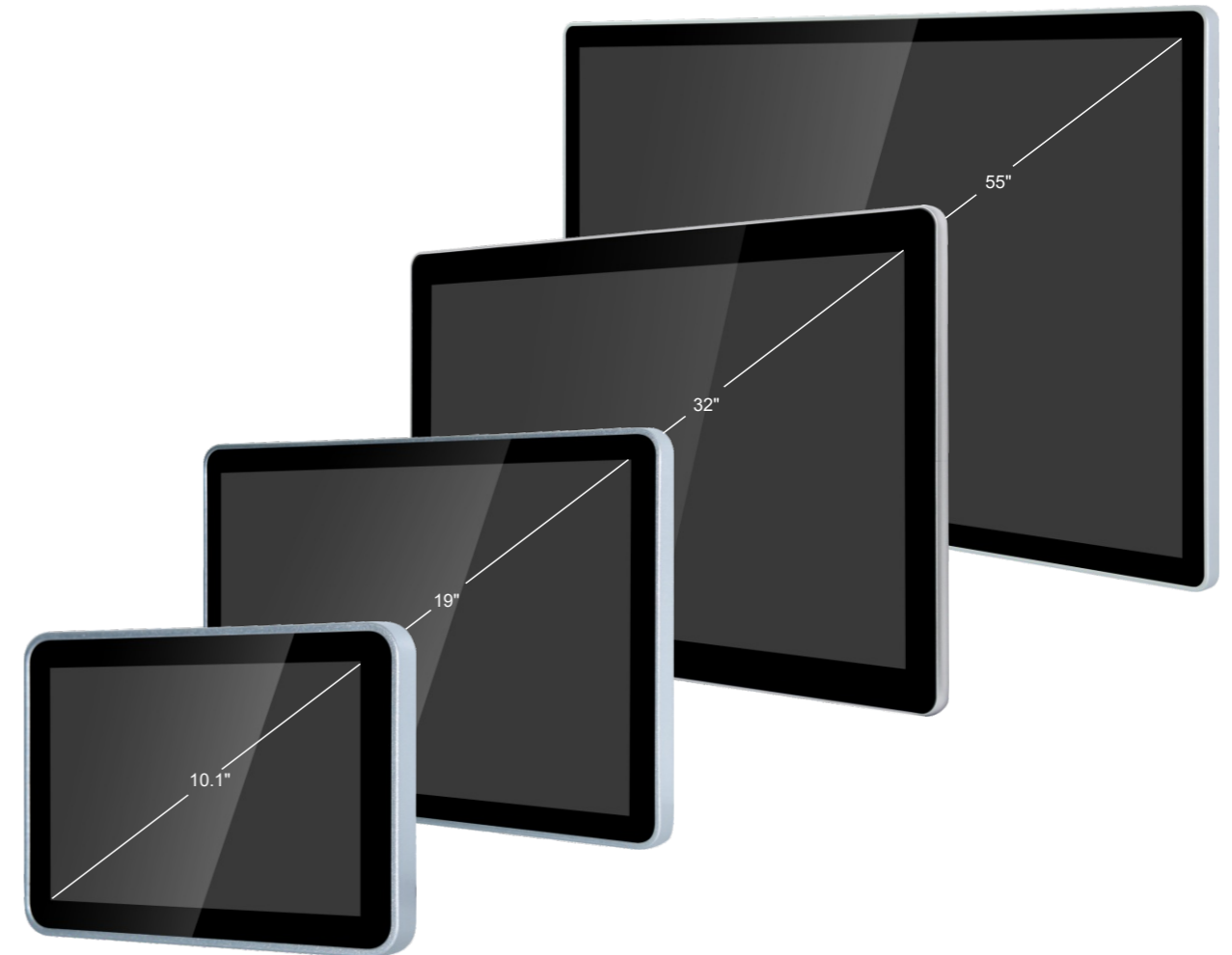

Application

- POS
- Hotel
- Self-service Terminal
- Public Information Display
- Hospitality
- In-vehicle And Transportation

Design/Material

- 10"-65" Optional
- Ultra-thin Style
- Tempered Glass Protection
- Aluminum Frame With Silver Color
- Rear With Metal Material
- Wall-mounting Bracket Optional



AZ Android Network Display

- a. Android 7.1/8.1/9.0 operating system optional
- b. RK 3288 / RK 3399 optional
- c. 2GB/4GB RAM (DDR3) optional
- d. 8GB/16GB/32GB/64GB flash optional
- e. 4G(optional)/WLAN/WiFi network connection
- f. 802.11 B/G/N Internal WiFi
- g. Portrait/landscape display mode
- h. 1080P display output
- i. Remote management software (CMS) optional

PC All-in-one Windows Display

- a. CPU: Intel® Celeron® Processor J1900 /Intel® Core® Processor I3/I5/I7
- b. Chipset: Intel Bay trail SOC /Intel® H310 Chipset
- c. System memory: 4GB/8GB RAM, 120GB/240GB SSD
- d. Input connectors: VGA/HDMI/USB/RJ45/Audio
- e. Operating system: Windows 7/8/10, Linux
- f. Preinstall Intel OS service optional



C Plug And Play Advertising Display

- a. Support picture, music and video to 1080P
- b. Support SD/HDMI/USB inputs
- c. Support SD card plug and play automatically
- d. USB update function: update documents by USB drive to SD card
- e. Support connecting with media player box/PC by HDMI input
- f. Playlist function: auto play the designated file at the specific date
- g. Timer function: 5 groups timers to turn on/off at the designated time
- h. Slideshow functions to play music and pictures at the same time
- i. Portrait/landscape display mode
- j. Scrolling text with different color and effect

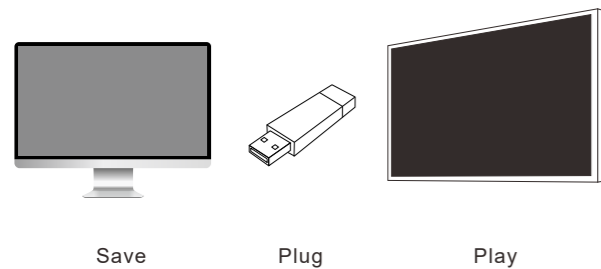

M LCD Monitor

- a. Professional design for 7-24 hours operation
- b. DP/HDMI/VGA inputs
- c. Full HD resolution supported
- d. Support connecting with media player box/PC by HDMI input



PANEL SPECIFICATIONS

Model No	RCS-101J	RCS-191J	RCS-220J	RCS-320J	RCS-430J	RCS-550J
Panel Model	10.1inch TFT LED	19inch TFT LCD	21.5inch TFT LED	32inch TFT LED	43inch TFT LED	55inch TFT LED
Max Resolution	1280×800	1440x900	1920x1080	1920x1080	1920x1080	1920x1080
Aspect Ratio	16:10	16:10	16:09	16:09	16:09	16:09
Pixel Pitch	0.1659×0.1659	0.2835x0.2835	0.24795×0.24795	0.36375x0.36375	0.4903×0.4903	0.63x0.63
Viewing Angle	85/85/85/85	85/85/80/80	89/89/89/89	89/89/89/89	89/89/89/89	89/89/89/89
Contrast Ratio	1300:1	1000:1	1000:1	1400:1	1200:1	1400:1
Brightness	350cd/m ²	250cd/m ²	250cd/m ²	500cd/m ²	500cd/m ²	500cd/m ²
Response Time	25ms	5ms	14ms	6.5ms	26ms	6ms
Display Area (mm)	216.96×135.60	408.24x255.15	476.064x267.786mm	698.4x392.85	941.184x592.416	1209.6x680.4
Panel Size(mm)	241.86×161.6×5.2	428x278x11	495.6x292.2x10.7mm	727.4x429x227	973x565.8x29	1244.6x720.9x27
Screen Weight	180g	1.57Kg	2Kg	4.8Kg	11Kg	17.5Kg
Lamp Type	WLED	WLED	WLED	WLED	WLED	WLED
Machine Weight	1.7KG	4.8KG	6.5KG	13.6KG	25KG	45KG
Dimensions(mm)	270x190x50	465x310x52	540x330x70	775x475x80	1020x615x80	1295x765x100
Speaker Type	5Wx2pcs	5Wx2pcs	5Wx2pcs	10Wx2pcs	10Wx2pcs	10Wx2pcs
Consumption	12 W	22 W	25 W	40 W	70 W	115 W
Power Input	DC 12V	DC 12V	AC100-240V	AC100-240V	AC100-240V	AC100-240V
VESA Mounting	75X75mm	100X100mm	100X100mm	300X300mm	400X400mm	400X400mm
Media Players	Android System / Windows System / Plug&play System / Monitor					
Mechanical	Cabinet Material	Body: Metal case; Side Frame: Aluminum				
Extended Function	Touch	IR Touch / Capacitive (PCAP) Touch				
	Motion Sensor	Optional				
	High Brightness	Normal/500nits/1000nits/1500nits/2000nits optional				
Accessories	Remote Control, Power supply, User manual, Keys, Tools and Screws					

J Series case





C Series

Optional size: 10.1"/12.1"/19"/22"/24"/27"/32"/43"/49"/55"/65"/75"/86"/98"

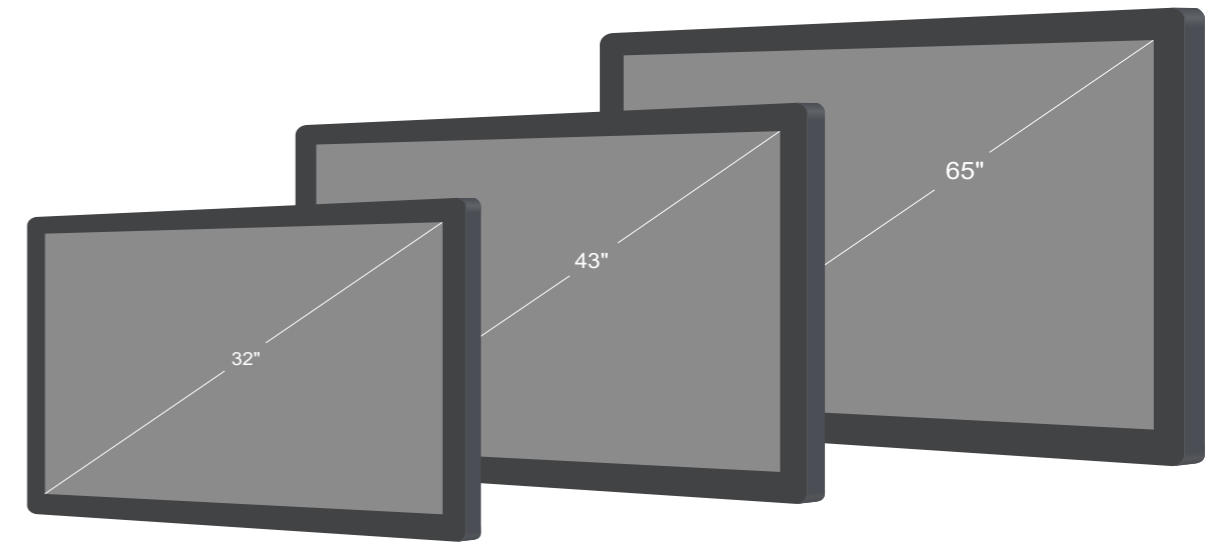

OP Series

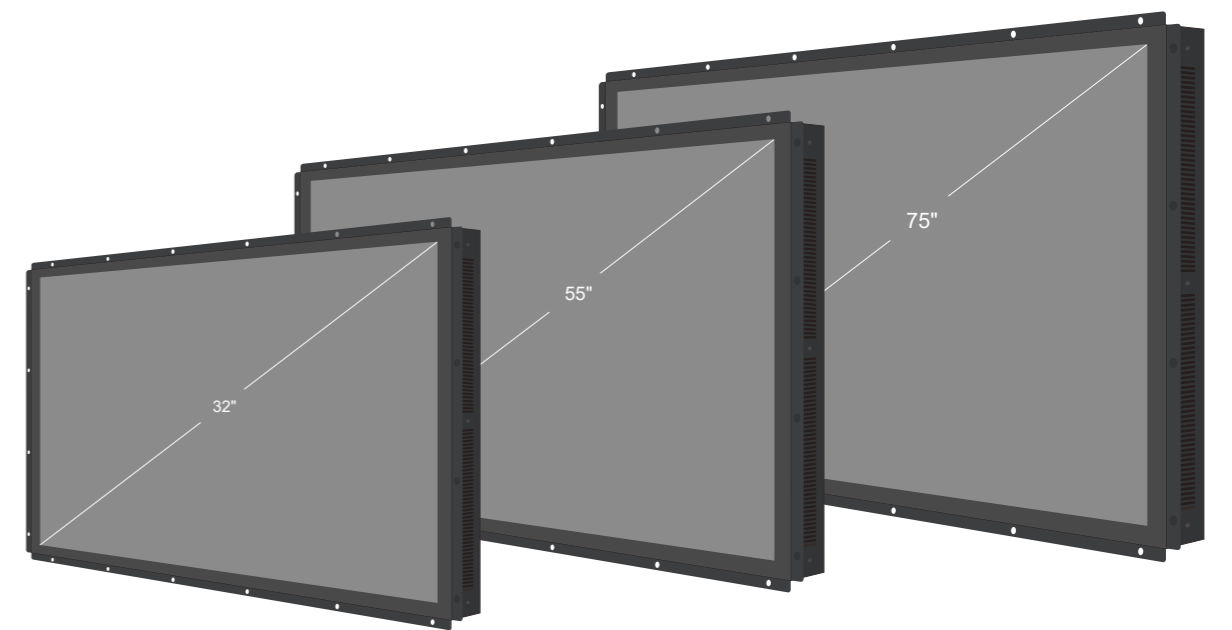

C/OP SERIES
Close Frame/Open Frame Wall mount Design



Application

- POS
- Hotel
- Self-service Terminal
- Public Information Display
- Hospitality
- In-vehicle And Transportation

Design/Material

- C Series:**
- 10"-98" Optional
 - Close Frame Design
 - Wall-mounting Bracket Optional
 - Color Optional
 - Rear With Metal Material

Design/Material

- OP Series:**
- 10"-98" Optional
 - Open Frame Design
 - Wall-mounting Bracket Optional
 - Color Optional
 - Rear With Metal Material

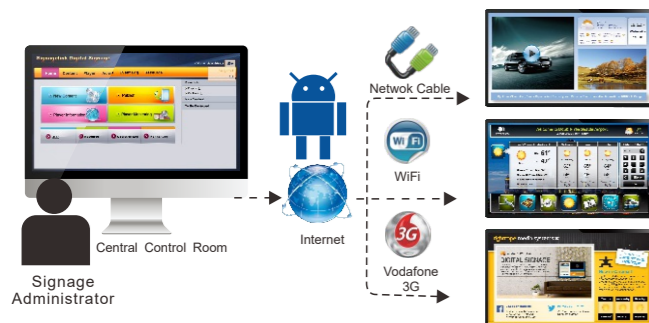

AZ Android Network Display

- a. Android 7.1/8.1/9.0 operating system optional
- b. RK 3288 / RK 3399 optional
- c. 2GB/4GB RAM (DDR3) optional
- d. 8GB/16GB/32GB/64GB flash optional
- e. 4G(optional)/WLAN/WiFi network connection
- f. 802.11 B/G/N Internal WiFi
- g. Portrait/landscape display mode
- h. 1080P display output
- i. Remote management software (CMS) optional

PC All-in-one Windows Display

- a. CPU: Intel® Celeron® Processor J1900 /Intel® Core® Processor I3/I5/I7
- b. Chipset: Intel Bay trail SOC /Intel® H310 Chipset
- c. System memory: 4GB/8GB RAM, 120GB/240GB SSD
- d. Input connectors: VGA/HDMI/USB/RJ45/Audio
- e. Operating system: Windows 7/8/10, Linux
- f. Preinstall Intel OS service optional



C Plug And Play Advertising Display

- a. Support picture, music and video to 1080P
- b. Support SD/HDMI/USB inputs
- c. Support SD card plug and play automatically
- d. USB update function: update documents by USB drive to SD card
- e. Support connecting with media player box/PC by HDMI input
- f. Playlist function: auto play the designated file at the specific date
- g. Timer function: 5 groups timers to turn on/off at the designated time
- h. Slideshow functions to play music and pictures at the same time
- i. Portrait/landscape display mode
- j. Scrolling text with different color and effect

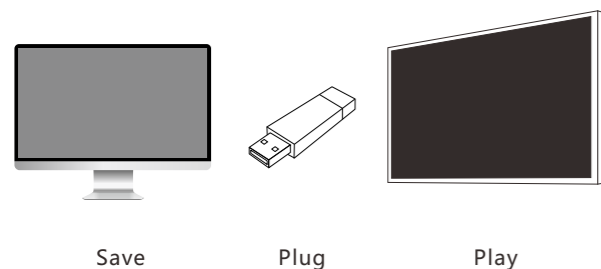

M LCD Monitor

- a. Professional design for 7-24 hours operation
- b. DP/HDMI/VGA inputs
- c. Full HD resolution supported
- d. Support connecting with media player box/PC by HDMI input



PANEL SPECIFICATIONS

Model No	RCS-101C	RCS-121C	RCS-151C	RCS-170C	RCS-185C
	RCS-101OP	RCS-121OP	RCS-151OP	RCS-170OP	RCS-185OP
Panel Model	10.1inch TFT LED	12.1inch TFT LED	15.6inch TFT LCD	17inch TFT LCD	18.5inch TFT LCD
Max Resolution	1280x800	1280x800(WXGA)	1920x1080	1280x1024	1366x768
Aspect Ratio	16:10	16:10	16:09	5:04	16:9
Pixel Pitch	0.1659x0.1659	0.204x0.204	0.17925x0.17925	0.264x0.264	0.300x0.300
Viewing Angle	85/85/85/85	80/80/65/80	85/85/85/85	88/88/88/88	89/89/89/89
Contrast Ratio	1300:1	800:1	700:1	1000:1	1000:1
Brightness	350cd/m ²	400cd/m ²	300cd/m ²	400cd/m ²	300cd/m ²
Response Time	25ms	35ms	25ms	30ms	14ms
Display Area (mm)	216.96x135.60	261.12x163.2	344.16x193.59	337.92x270.336	409.8x230.4
Panel Size(mm)	241.86x161.6x5.2	278x184x8.6	359.5x223.8x3.2	358.5x296.5x13.4	430.4x254.6x7.8
Screen Weight	180G	550G	1.2KG	1.27KG	1.29KG
Lamp Type	WLED	WLED	WLED	WLED	WLED
Machine Weight	0.9KG	1.8KG	3.3KG	4.1KG	4.8KG
Dimensions(mm)	246x168x32.5	301x203x44	344x268x51	429x319x45	465x315x50
Speaker Type	5Wx2pcs	5Wx2pcs	5Wx2pcs	5Wx2pcs	5Wx2pcs
Consumption	12 W	15 W	16 W	17 W	18 W
Power Input	DC 12V	DC 12V	DC 12V	DC 12V	DC 12V
VESA Mounting	75x75mm	75x75mm	75x75mm	75x75mm	100x100mm
Media Players	Android System / Windows System / Plug&play System / Monitor				
Mechanical	Cabinet Material	Body: Metal case			
Extended Function	Touch	IR Touch / Capacitive (PCAP) Touch			
	Motion Sensor	Optional			
	High Brightness	Normal/500nits/1000nits/1500nits/2000nits optional			
Accessories	Remote Control, Power supply, User manual, Keys, Tools and Screws				

C Series case



PANEL SPECIFICATIONS						
Model No	RCS-191C	RCS-220C	RCS-240C	RCS-270C	RCS-320C	RCS-430C
	RCS-191OP	RCS-220OP	RCS-240OP	RCS-270OP	RCS-320OP	RCS-430OP
Panel Model	19inch TFT LCD	21.5inch TFT LED	23.8inch TFT LED	27inch TFT LED	32inch TFT LED	43inch TFT LED
Max Resolution	1440x900	1920x1080	1920x1080	1920x1080	1920x1080	1920x1080
Aspect Ratio	16:10	16:09	16:9	16:09	16:09	16:09
Pixel Pitch	0.2835x0.2835	0.24795x0.24795	0.2745x0.2745	0.31125x0.31125	0.36375x0.36375	0.4903x0.4903
Viewing Angle	85/85/80/80	89/89/89/89	89/89/89/89	85/85/80/80	89/89/89/89	89/89/89/89
Contrast Ratio	1000:1	1000:1	1000:1	1200:1	1400:1	1200:1
Brightness	250cd/m ²	250cd/m ²	250cd/m ²	300cd/m ²	500cd/m ²	500cd/m ²
Response Time	5ms	14ms	15ms	12ms	6.5ms	26ms
Display Area (mm)	408.24x255.15	476.064x267.786mm	527.04x296.46	597.6x336.15	698.4x392.85	941.184x592.416
Panel Size(mm)	428x278x11	495.6x292.2x10.7mm	543x317.4x11.6	630x368.2x15	727.4x429x227	973x565.8x29
Screen Weight	1.57Kg	2Kg	2.27Kg	2.35Kg	4.8Kg	11Kg
Lamp Type	WLED	WLED	WLED	WLED	WLED	WLED
Machine Weight	3.6KG	4.5KG	5.9KG	6.2KG	9.4KG	23.4KG
Dimensions(mm)	445x292x47.5	515x305x45	597x364x47.5	647.5x386x50	774.5x469x55.5	998.4x593x57.5
Speaker Type	5Wx2pcs	5Wx2pcs	10Wx2pcs	10Wx2pcs	10Wx2pcs	10Wx2pcs
Consumption	22 W	25 W	31 W	32 W	40 W	70 W
Power Input	DC 12V	DC12V	DC12V	AC100-240V	AC100-240V	AC100-240V
VESA Mounting	100x100mm	100x100mm	100x100mm	100x100mm	300x300mm	400x400mm
Media Players	Android System / Windows System / Plug&play System / Monitor					
Mechanical	Cabinet Material	Body: Metal case				
Extended Function	Touch	IR Touch / Capacitive (PCAP) Touch				
	Motion Sensor	Optional				
	High Brightness	Normal/500nits/1000nits/1500nits/2000nits optional				
Accessories	Remote Control, Power supply, User manual, Keys, Tools and Screws					

OP Series case



PANEL SPECIFICATIONS						
Model No	RCS-490C	RCS-550C	RCS-650C	RCS-750C	RCS-860C	RCS-980C
	RCS-490OP	RCS-550OP	RCS-650OP	RCS-750OP	RCS-860OP	RCS-980OP
Panel Model	49inch TFT LCD	55inch TFT LED	65 inch TFT LED	75 inch TFT LCD	86inch TFT LCD	98inch TFT LCD
Max Resolution	1920x1080	1920x1080	3840x2160	3840x2160	3840x2160	3840x2160
Aspect Ratio	16:09	16:09	16:09	16:09	16:09	16:09
Pixel Pitch	0.53025*0.53025	0.63x0.63	0.372x0.372	0.4296x0.4296	0.4935x0.4935	0.5622x0.5622
Viewing Angle	89/89/89/89	89/89/89/89	89/89/89/89	89/89/89/89	89/89/89/89	89/89/89/89
Contrast Ratio	1000:1	1400:1	1400:1	1200:1	1200:1	1300:1
Brightness	500cd/m ²	500cd/m ²	500cd/m ²	500cd/m ²	500cd/m ²	500cd/m ²
Response Time	12ms	6ms	13ms	8ms	8ms	8ms
Display Area (mm)	1073.78x604	1209.6x680.4	1428.48x803.52	1649.66x927.936	1895.04x1065.96	2158.85x1214.35
Panel Size(mm)	1096.2x632.5x29	1244.6x720.9x27	1459.2x830x16	1675.2x953.6x11.9	1922.2x1093.2x13.6	2187.8x1242.8x68.6
Screen Weight	18Kg	17.5Kg	22.7Kg	36Kg	39.9Kg	59Kg
Lamp Type	WLED	WLED	WLED	WLED	WLED	WLED
Machine Weight	30.1KG	30.9KG	50KG	73.5KG	156KG	200KG
Dimensions(mm)	1227x662x85	1269.5x749x62	1495x870x72.5	1635x960x70	1946x1132.5x75	2238x1293x135
Speaker Type	10Wx2pcs	10Wx2pcs	10Wx2pcs	10Wx2pcs	10Wx2pcs	10Wx2pcs
Consumption	98 W	115 W	230 W	370 W	500 W	550 W
Power Input	AC100-240V	AC100-240V	AC100-240V	AC100-240V	AC100-240V	AC100-240V
VESA Mounting	400x400mm	400x400mm	400x400mm	600x300x300mm	600x300x300mm	600x300x300mm
Media Players	Android System / Windows System / Plug&play System / Monitor					
Mechanical	Cabinet Material	Body: Metal case				
Extended Function	Touch	IR Touch / Capacitive (PCAP) Touch				
	Motion Sensor	Optional				
	High Brightness	Normal/500nits/1000nits/1500nits/2000nits optional				
Accessories	Remote Control, Power supply, User manual, Keys, Tools and Screws					

OP Series case

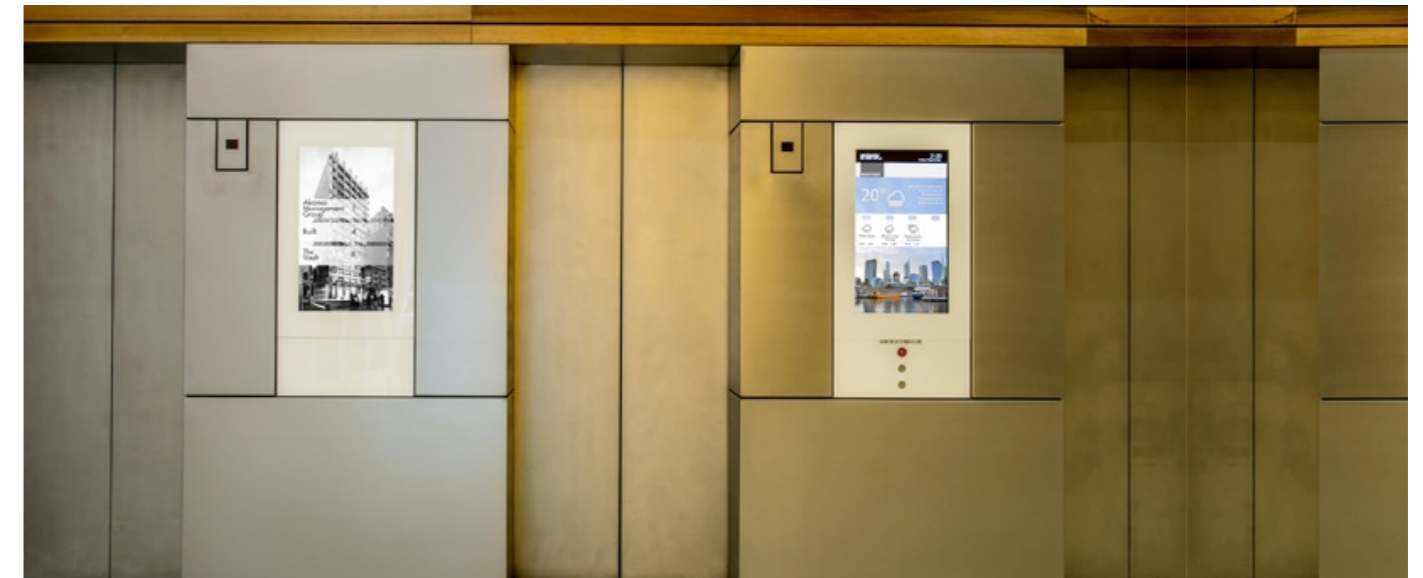



K SERIES

Stretched Display



Optional size: 14.9"/19.1"/23.1"/28.8"/38"/57.2"

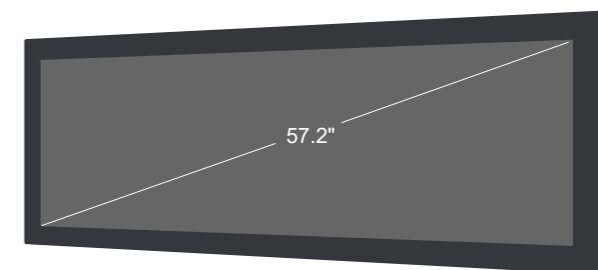
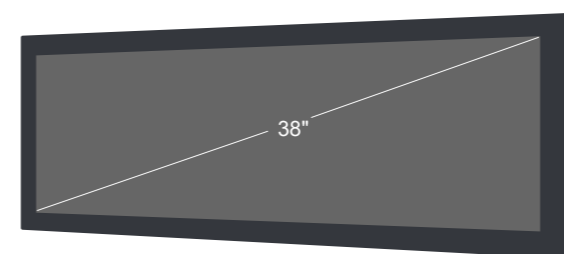
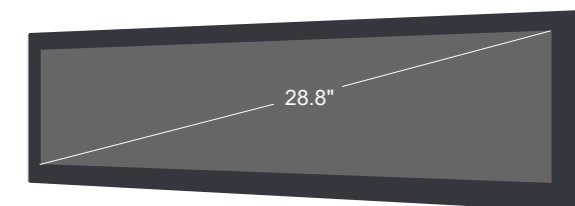
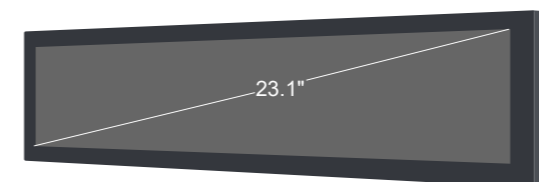
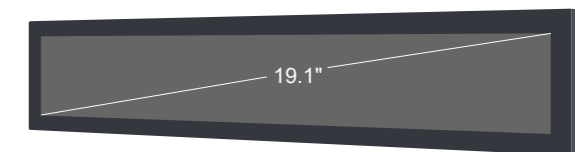
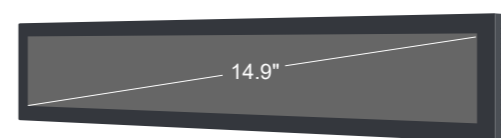

Application

- POS
- Hotel
- Self-service Terminal
- Supermarket
- Public Information Display
- Hospitality
- In-vehicles And Transportation

Design/Material

- 14.9"-57.2" Optional
- Close Frame Design
- Wall-mounting Bracket Optional
- Color Optional
- Rear With Metal Material

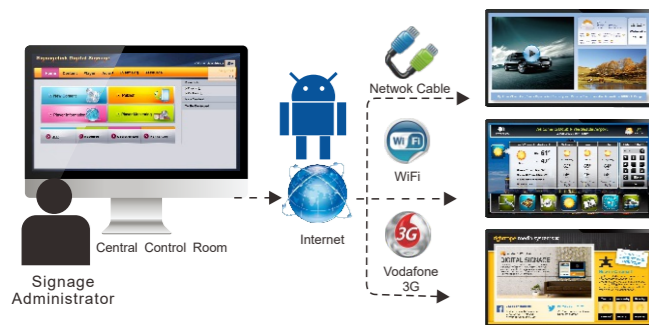

AZ Android Network Display

- a. Android 7.1/8.1/9.0 operating system optional
- b. RK 3288 / RK 3399 optional
- c. 2GB/4GB RAM (DDR3) optional
- d. 8GB/16GB/32GB/64GB flash optional
- e. 4G(optional)/WLAN/WiFi network connection
- f. 802.11 B/G/N Internal WiFi
- g. Portrait/landscape display mode
- h. 1080P display output
- i. Remote management software (CMS) optional

K Plug And Play Advertising Display

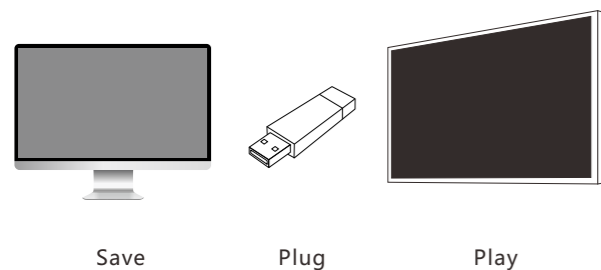

- a. Support picture, music and video to 1080P
- b. Support SD/HDMI/USB inputs
- c. Support SD card plug and play automatically
- d. USB update function: update documents by USB drive to SD card
- e. Support connecting with media player box/PC by HDMI input
- f. Playlist function: auto play the designated file at the specific date
- g. Timer function: 5 groups timers to turn on/off at the designated time
- h. Slideshow functions to play music and pictures at the same time
- i. Portrait/landscape display mode
- j. Scrolling text with different color and effect

M LCD Monitor



- a. Professional design for 7-24 hours operation
- b. DP/HDMI/VGA inputs
- c. Full HD resolution supported
- d. Support connecting with media player box/PC by HDMI input

KEY FEATURES

- Ultra Stretch Design
- Close Frame/ Open Frame Design
- 75x75/100x100 Vesa mounting holes
- Color Optional
- Splitter screen playback

PANEL SPECIFICATIONS

Model No	RCS-150K	RCS-191K	RCS-231KAZ	RCS-380K	RCS-572K
Panel Model	14.9inch TFT LCD	19inch TFT LCD	23.1inch TFT LCD	38inch TFT LED	57.2 inch TFT LED
Max Resolution	1280x390	1920x340	1920x158	1920x540	1920x364
Aspect Ratio	>3:1	>3:1	3:1	<16:6	>5:2
Pixel Pitch	0.282x0.282	0.24825x0.24825	0.10167x0.305	0.1615x0.4845	0.744x0.744
Viewing Angle	70/70/50/70	85/85/80/80	88/88/88/88	88/88/88/88	89/89/89/89
Contrast Ratio	500:1	1000:1	3000:1	3000:1	500:1
Brightness	400cd/m ²	700cd/m ²	500cd/m ²	700cd/m ²	700cd/m ²
Response Time	30ms	5ms	9.5ms	8ms	10ms
Display Area (mm)	360.94x109.98	476.64x84.405 mm	587.6 x 48.19	919.3x258	1429x272.2
Panel Size(mm)	407.5x136 x20.5	495.6x108.5x11	597.4x60.4x14.5mm	972x304x29.6	1470x314.2x29
Screen Weight	890g	1.78Kg	0.435kg	5kg	10Kg
Lamp Type	WLED	WLED	WLED	WLED	WLED
Machine Weight	2.3 KG	2.5 KG	0.335 KG	9.8 KG	11 KG
Dimensions(mm)	420x40x170	521.5x44x129	597.4x15x60.4	1077.5x60x345.5	1478x67x322.2
Speaker Type	5Wx2pcs	5Wx2pcs		5Wx2pcs	5Wx2pcs
Consumption	15 W	41 W	4.1 W	46 W	60 W
Power Input	DC12V	DC12V	DC12V	DC12V	DC12V
VESA Mounting	75x75mm	75x75mm		400x400mm	400x400mm
Media Players	Android System / Plug&play System / Monitor				
Mechanical	Cabinet Material	Body: Metal case			
Accessories	Remote Control, Power supply, User manual, Keys, Tools and Screws				

K Series case





W SERIES

LCD Video Wall Display



Vormatic LCD Video wall solutions provide for all-in-one, easy-to-configure solution that is ideal for dynamic digital signage, information display and command & control applications.

Our Video wall panels make your digital signage easy to implement, configure and operate. Video wall displays support an extensive array of connectivity options, including VGA, DVI, HDMI, Composite, and supports RC-232 Serial connectivity for multiple display control. The ultra-thin bezel (4mm) make these displays appear nearly seamless for video walls consisting of up to 250 displays. Our video wall software allows you to change, reposition and resize content in real time from a single PC or Media Player box. No matter where you display these screens you can be assured people will be captivated by your message.

Optional size: 46"/49"/55"

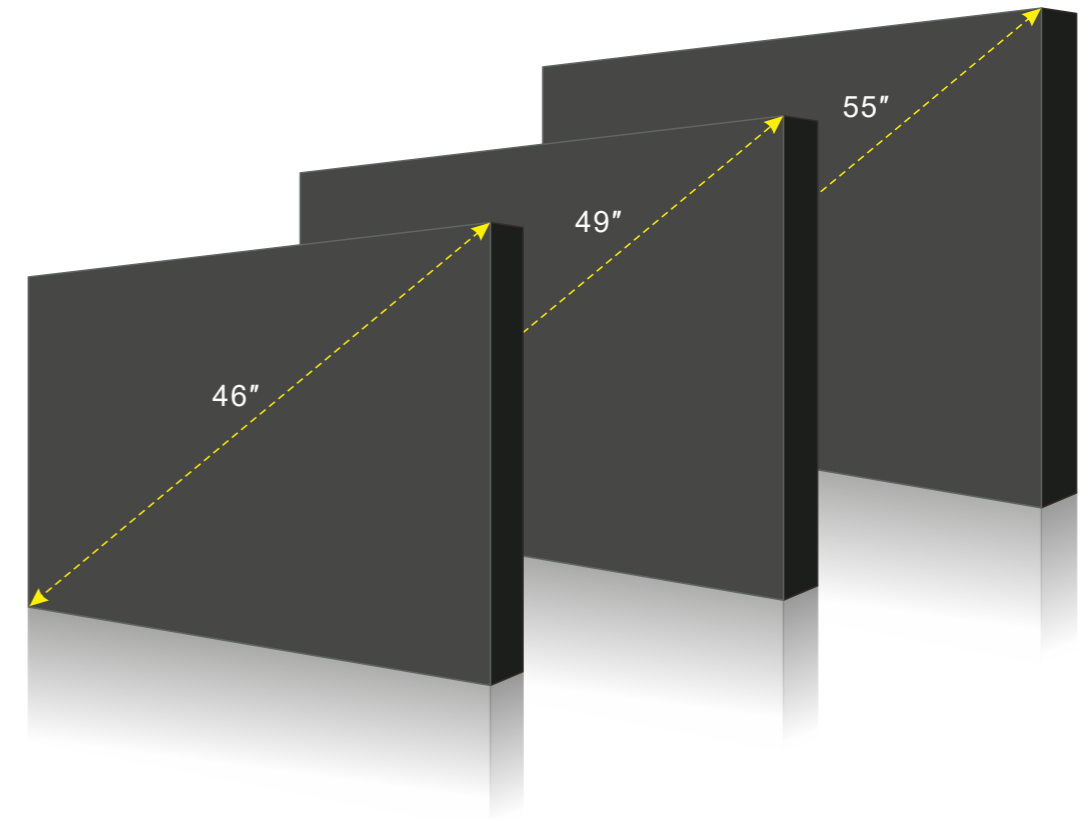

Application

- Hospitals
- Retail Stores
- Shopping Malls
- Supermarkets
- Museums and Galleries
- Airports

Design/Material

- 46"-55" Optional
- Slim Bezel design
- LG/Samsung LCD Panel
- 1920x1080 Full HD Resolution
- Artistic video wall software supported

KEY FEATURES

Super Narrow Bezel

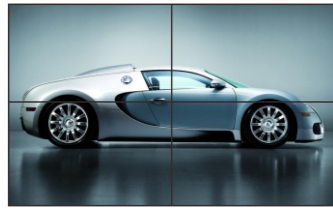

Bezel to Bezel
1.8mm

2.25(Left/top)/1.25mm(Right/Bottom)

Featuring an extremely narrow bezel width of 1.8mm/3.5mm /5.5 mm, Vormatic's LCD video wall displays provide a near seamless image for public venues and control rooms.

Auto Color Calibration



VS



Before

After

Vormatic LCD video wall features an auto color calibration tool to ensure a uniform Image across the entire tiled LCD display. The calibration sensor is placed on the screen and communicates with the video wall through either USB or RS232. It automatically adjusts the color and brightness to ensure all individual displays closely match.

Create Dynamic Video Walls

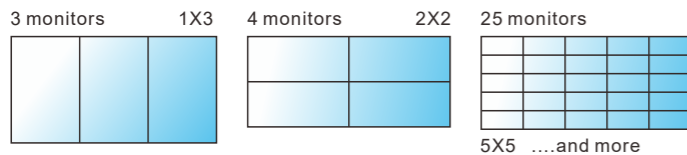

Vormatic's video wall monitors can be joined together to build all kinds of multi-screen configurations. The features of LCD monitor is easy to control and install, what are needed in order to produce a professional video wall display.

Software Control

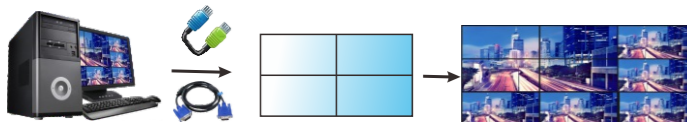

Connect and control your video wall from a central admin computer. Using display-based software to manage your network of displays from a single location via RJ45 and Rs232. Easily identify your displays and fine-tune all display settings including brightness, contrast, saturation and sharpness.

Comprehensive Set of Inputs

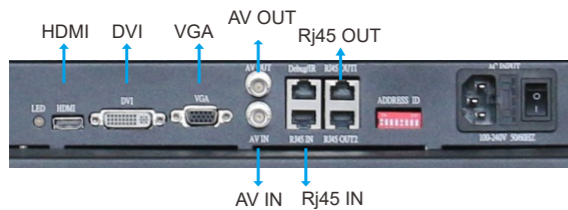

Vormatic's LCD video walls come with a full array of connectivity and control options including DVI, HDMI, VGA and RJ45, RS232 AV OUT and AV IN.

Installation optional



1 wall mounted

2 freestanding

Vormatic's video wall design allows you to mount any landscape or portrait video wall configuration with any number of screens, designed with the wall mount bracket, free standing type bracket optional. Which enables clients to find the cost-effective solution to fit their needs.

PANEL SPECIFICATIONS

Model No	RCS-460W	RCS-490W	RCS-550W	RCS-550W
Panel Model	46" TFT-LCD	49" TFT-LCD	55" TFT-LCD	55" TFT-LCD
Aspect Ratio	16:9	16:9	16:9	16:9
Max Resolution	1920x1080	1920x1080	1920x1080	1920x1080
Display color	16.7M	16.7M	16.7M	16.7M
Chroma	97%	97%	97%	97%
Brightness	500/700cd/m ²	500/700cd/m ²	500/700cd/m ²	500/700cd/m ²
Brightness Type	LED	LED	LED	LED
Seam(mm)	≤3.5mm	≤1.8mm ≤3.5mm	≤1.8mm ≤3.5mm	≤1.7mm
Contrast	3000:1	3000:1	3000:1	3000:1
Visual Angle	178°/178°	178°/178°	178°/178°	178°/178°
Response Time	8ms	8ms	8ms	8ms
Life(hrs)	>50,000(hrs)	>50,000(hrs)	>50,000(hrs)	>50,000(hrs)
APPEARANCE				
Dimension (mm)	1024x122x579	1077.58x109.5x607.8	1211.4x111.7x682.2	1211.54x682.34x125.3
Color	Matte Black	Matte Black	Matte Black	Matte Black
Panel Material	Metal case SPCC	Metal case SPCC	Metal case SPCC	Metal case SPCC
Installation	Wall-mounted	Wall-mounted	Wall-mounted	Wall-mounted
POWER				
Power Supply	AC 100-240V 50/60Hz			
Power Consumption (Max)	≤220W	≤220W	≤220W	≤300W
Power Consumption (Min)	<5W	<5W	<5W	<5W
INTERFACE				
DVI 1input	HDMI 1input	VGA 1input	CVBS 1input & 1output	Rs232 1input & 2output
				ON/OFF x1
VIDEO				
Color System			OSD display(screen menu display)	
PAL/NTSC/SECAM			Menu language	Chinese/English(multiple language option required)

W Series case





H SERIES

Semi-outdoor Display



KEY FEATURES

AG Glass with Anti-reflective Function

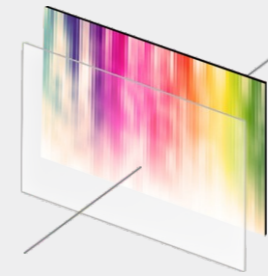

Anti-reflective AG glass can avoid interfere of ultraviolet radiation.

Sunlight Readable

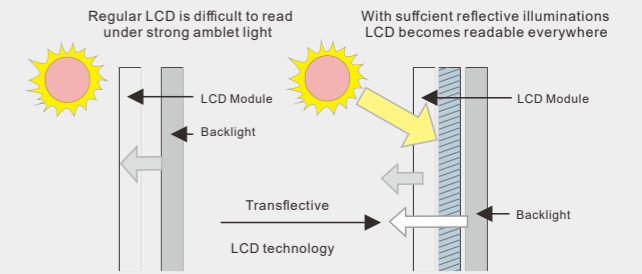

The high brightness outdoor displays with 2000nits, maintains high picture quality and image readability in an outdoor environments.

Smart Fans for Cooling

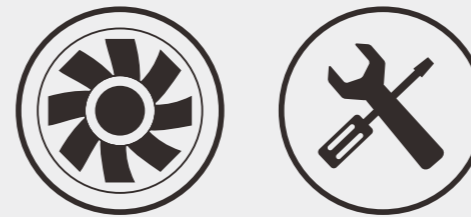

Self-cooling solution, equips this display to handle a wide operating temperature range, from 0°C-35°C.

Auto Brightness Sensor

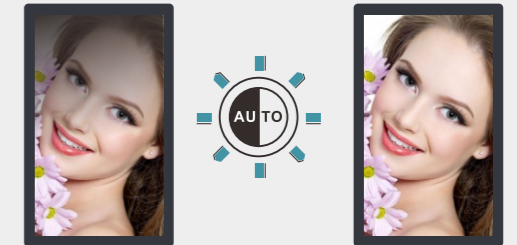

Screen brightness is automatically adjusted by its surrounding illumination level.

Touch Options

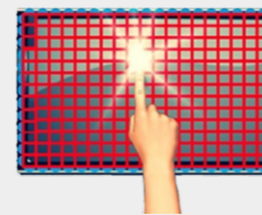

Grid of Infrared light Photo Transistors

Vormatic LCD Monitor could be with touch function, namely resistive, touch, Infrared Touch and capacitive options.

Close-Frame/Open Frame Type Options

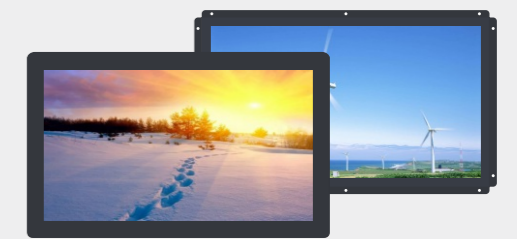

Vormatic could provide OEM/ODM service, so monitor could be with close frame and open frame different design

Colour Options



Welcome different colors for the metal case.

Brightness Options

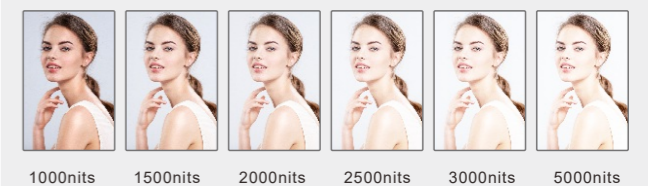

Depending on different application environment, Vormatic monitor could be with different brightness, such as 500nits/1000nits/1500nits/2000nits /2500nits/3000nits/5000nits.

H SERIES

19" Semi-Outdoor High Brightness LCD Monitor

1000 nits

PANEL SPECIFICATIONS	
Model No	RCS-191HCM/HOPM
Panel Model	19inch TFT LCD
Max Resolution	1440x900
Aspect Ratio	16:10
Pixel Pitch	0.2835x0.2835
Viewing Angle	85/85/80/80
Contrast Ratio	1000:1
Brightness	1000cd/m ²
Response Time	5ms
Display Area (mm)	408.24x255.15
Panel Size(mm)	428x278x11
Screen Weight	1.57Kg
Lamp Type	WLED
Machine Weight	3.6KG
Dimensions(mm)	455x305x50
Speaker Type	5Wx2pcs
Consumption	54 W
Power Input	DC 12V
VESA Mounting	100x100mm
CONNECTORS(Input)	
HDMI	x2
VGA	x1
DP	x1
Audio	3.5mm Stereo Jack
ON/OFF	Switch x1
ENVIRONMENTAL	
Operating Temperature	0-50 degree
Storage Temperature	0-65 degree
Operating Humidity	20%-80%Noncondensing
Storage Humidity	10%-90%Noncondensing
MECHANICAL	
Cabinet Material	Metal
Finish	Black
Mount	Wall mounting

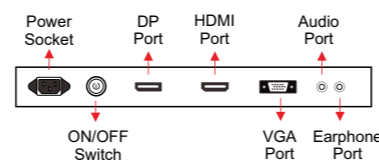
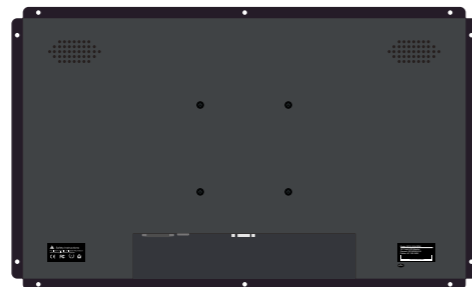
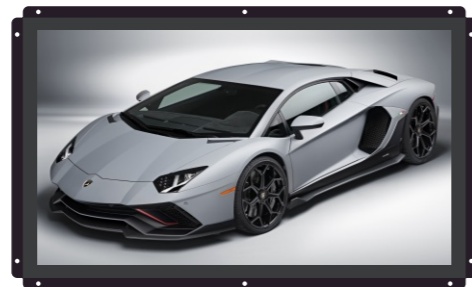
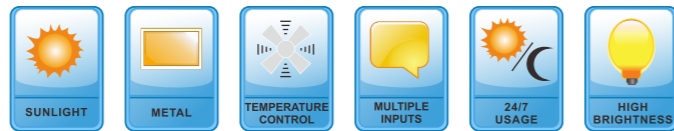

Features

- ※ 1440x900 resolution
- ※ 1000nits high brightness
- ※ DP / HDMI / VGA Input
- ※ Built in small fans for cooling
- ※ 75x75mm VESA holes
- ※ Sunlight readable function
- ※ Capacitive touch optional

1500 nits

PANEL SPECIFICATIONS	
Model No	RCS-240HCM/HOPM
Panel Model	23.8inch TFT LED
Max Resolution	1920x1080
Aspect Ratio	16:9
Pixel Pitch	0.2745x0.2745
Viewing Angle	89/89/89/89
Contrast Ratio	1000:1
Brightness	1500cd/m ²
Response Time	15ms
Display Area (mm)	527.04x296.46
Panel Size(mm)	543x317.4x11.6
Screen Weight	2.27Kg
Lamp Type	WLED
Machine Weight	6.9KG
Dimensions(mm)	590x50x355
Speaker Type	10Wx2pcs
Consumption	67 W
Power Input	DC12V
VESA Mounting	100x100mm
CONNECTORS(Input)	
HDMI	x2
VGA	x1
DP	x1
Audio	3.5mm Stereo Jack
ON/OFF	Switch x1
ENVIRONMENTAL	
Operating Temperature	0-50 degree
Storage Temperature	0-65 degree
Operating Humidity	20%-80%Noncondensing
Storage Humidity	10%-90%Noncondensing
MECHANICAL	
Cabinet Material	Metal
Finish	Black
Mount	Wall mounting

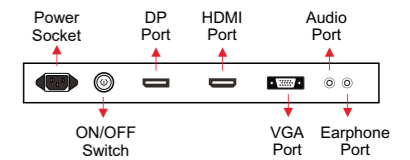
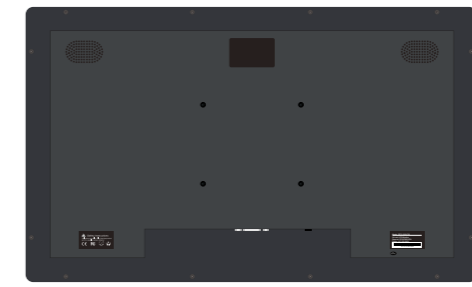
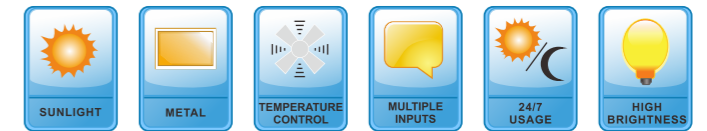

Features

- ※ 1920x1080 resolution
- ※ 1500nits high brightness
- ※ DP / HDMI / VGA Input
- ※ Built in small fans for cooling
- ※ 100x100mm VESA holes
- ※ Sunlight readable function
- ※ Capacitive touch optional

H SERIES

32" Semi-Outdoor High Brightness LCD Monitor

1500 nits

PANEL SPECIFICATIONS	
Model No	RCS-320HCM/HOPM
Panel Model	32inch TFT LED
Max Resolution	1920x1080
Aspect Ratio	16:09
Pixel Pitch	0.36375x0.36375
Viewing Angle	89/89/89/89
Contrast Ratio	1400:1
Brightness	1500cd/m ²
Response Time	6.5ms
Display Area (mm)	698.4x392.85
Panel Size(mm)	727.4x429x227
Screen Weight	4.8Kg
Lamp Type	WLED
Machine Weight	21.5KG
Dimensions(mm)	754x47x451
Speaker Type	10Wx2pcs
Consumption	228 W
Power Input	AC100-240V
VESA Mounting	300x300mm
CONNECTORS(Input)	
HDMI	x2
VGA	x1
DP	x1
Audio	3.5mm Stereo Jack
ON/OFF	Switch x1
ENVIRONMENTAL	
Operating Temperature	0-50 degree
Storage Temperature	0-65 degree
Operating Humidity	20%-80%Noncondensing
Storage Humidity	10%-90%Noncondensing
MECHANICAL	
Cabinet Material	Metal
Finish	Black
Mount	Wall mounting

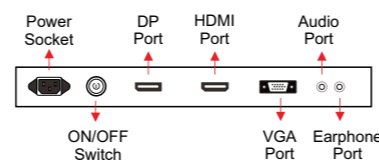
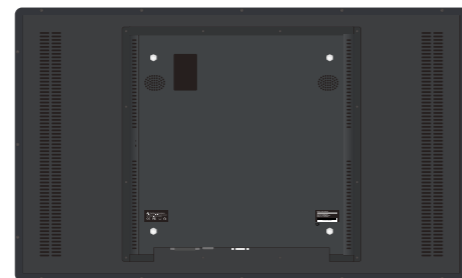
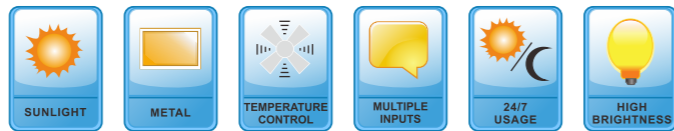

Features

- ※ 1920x1080 resolution
- ※ 1500nits high brightness
- ※ DP / HDMI / VGA Input
- ※ Built in small fans for cooling
- ※ 200x200mm vesa holes
- ※ Sunlight readable function
- ※ Capacitive touch optional

H SERIES

49" Semi-Outdoor High Brightness LCD Monitor

1500 nits

PANEL SPECIFICATIONS	
Model No	RCS-490HCM/HOPM
Panel Model	49inch TFT LCD
Max Resolution	1920x1080
Aspect Ratio	16:09
Pixel Pitch	0.53025*0.53025
Viewing Angle	89/89/89/89
Contrast Ratio	1000:1
Brightness	1500cd/m ²
Response Time	12ms
Display Area (mm)	1073.78x604
Panel Size(mm)	1096.2x632.5x29
Screen Weight	18Kg
Lamp Type	WLED
Machine Weight	30.1KG
Dimensions(mm)	1227x85x662
Speaker Type	10Wx2pcs
Consumption	160 W
Power Input	AC100-240V
VESA Mounting	400x400mm
CONNECTORS(Input)	
HDMI	x2
VGA	x1
DP	x1
Audio	3.5mm Stereo Jack
ON/OFF	Switch x1
ENVIRONMENTAL	
Operating Temperature	0-50 degree
Storage Temperature	0-65 degree
Operating Humidity	20%-80%Noncondensing
Storage Humidity	10%-90%Noncondensing
MECHANICAL	
Cabinet Material	Metal
Finish	Black
Mount	Wall mounting

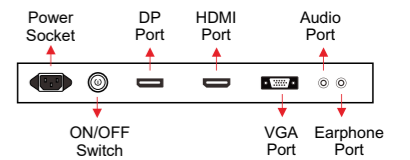
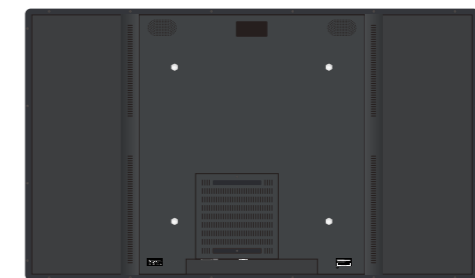
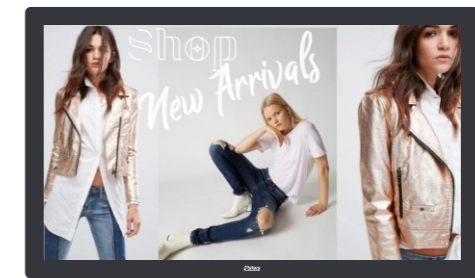
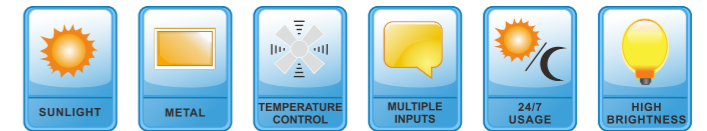

Features

- ※ 1920x1080 resolution
- ※ 1500nits high brightness
- ※ DP / HDMI / VGA Input
- ※ Built in small fans for cooling
- ※ 100x100mm vesa holes
- ※ Sunlight readable function
- ※ Capacitive touch optional

H SERIES

55" Semi-Outdoor High Brightness LCD Monitor

1500 nits

PANEL SPECIFICATIONS	
Model No	RCS-550HCM/HOPM
Panel Model	55inch TFT LED
Max Resolution	1920x1080
Aspect Ratio	16:09
Pixel Pitch	0.63x0.63
Viewing Angle	89/89/89/89
Contrast Ratio	1400:1
Brightness	1500cd/m ²
Response Time	6ms
Display Area (mm)	1209.6x680.4
Panel Size(mm)	1244.6x720.9
Screen Weight	17.5Kg
Lamp Type	WLED
Machine Weight	30.9KG
Dimensions(mm)	1269.5x62x749
Speaker Type	10Wx2pcs
Consumption	94 W
Power Input	AC100-240V
VESA Mounting	400x400mm
CONNECTORS(Input)	
HDMI	x2
VGA	x1
DP	x1
Audio	3.5mm Stereo Jack
ON/OFF	Switch x1
ENVIRONMENTAL	
Operating Temperature	0-50 degree
Storage Temperature	0-65 degree
Operating Humidity	20%-80%Noncondensing
Storage Humidity	10%-90%Noncondensing
MECHANICAL	
Cabinet Material	Metal
Finish	Black
Mount	Wall mounting

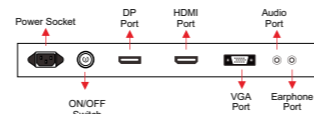
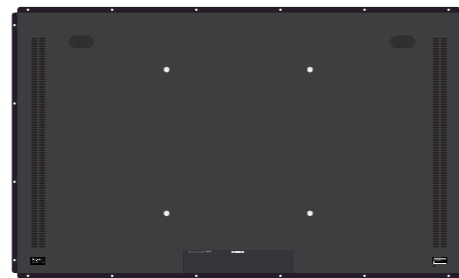
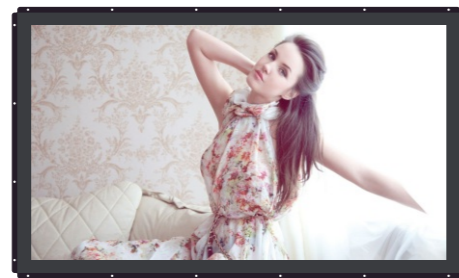
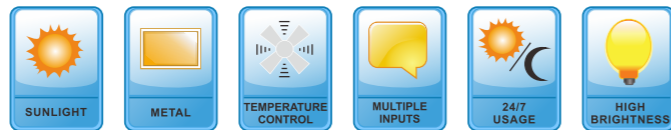

Features

- ※ 1920x1080 resolution
- ※ 1500nits high brightness
- ※ DP / HDMI / VGA Input
- ※ Built in small fans for cooling
- ※ 400x400mm vesa holes
- ※ Sunlight readable function
- ※ PCAP touch optional

2500 nits

PANEL SPECIFICATIONS	
Model No	RCS-860HCM/HOPM
Panel Model	86inch TFT LCD
Max Resolution	3840x2160
Aspect Ratio	16:09
Pixel Pitch	0.4935x0.4935
Viewing Angle	89/89/89/89
Contrast Ratio	1200:1
Brightness	2500cd/m ²
Response Time	8ms
Display Area (mm)	1895.04x1065.96
Panel Size(mm)	1922.2x1093.2x13.6
Screen Weight	39.9Kg
Lamp Type	WLED
Machine Weight	156KG
Dimensions(mm)	1946x1132.5x75
Speaker Type	10Wx2pcs
Consumption	500 W
Power Input	AC100-240V
VESA Mounting	600x300x300mm
CONNECTORS(Input)	
HDMI	x1
Audio	3.5mm Stereo Jack
ON/OFF	Switch x1
ENVIRONMENTAL	
Operating Temperature	0-50 degree
Storage Temperature	0-65 degree
Operating Humidity	20%-80%Noncondensing
Storage Humidity	10%-90%Noncondensing
MECHANICAL	
Cabinet Material	Metal
Finish	Black
Mount	Wall mounting

H SERIES

86" Semi-Outdoor High Brightness LCD Monitor

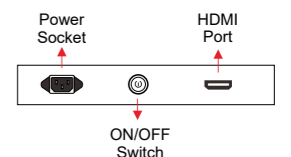
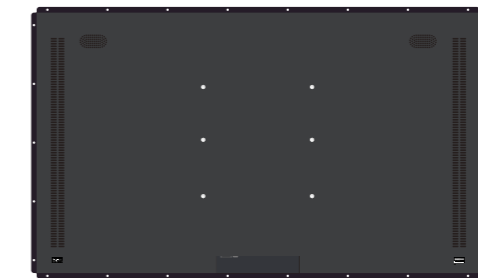
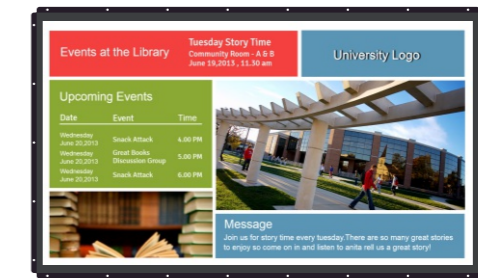
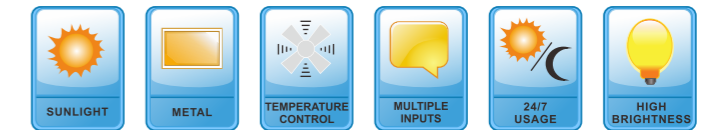

Features

- ※ 3840x2160 resolution
- ※ 2500nits high brightness
- ※ HDMI Input
- ※ Built in small fans for cooling
- ※ 600x600mm vesa holes
- ※ Sunlight readable



OD SERIES

Outdoor Display With Ip65 Grade



Excellent Visibility

High Brightness

Vormatic outdoor display have high brightness of 4,000 cd/m2 and antireflection glass, which delivers content clearly in the direct sunlight and catches the attention of viewers no matter where they are, achieve it to be excellent visibility.



Strong Reliability

IP65 Design Protection

Vormatic outdoor display with IP65 grade design and 24/7 for reliable operation. Which can support in any environment, sun, rain, snow, dust, etc.

Conformal Coating

The conformal coating protects the outdoor display against dust, iron powder and humidity, etc during maintenance.

Auto Brightness Control

The outdoor screen brightness can be automatically adjusted depending on the light.

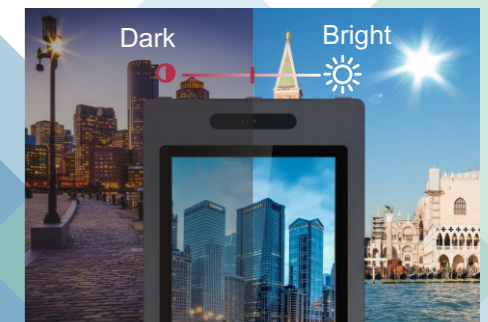
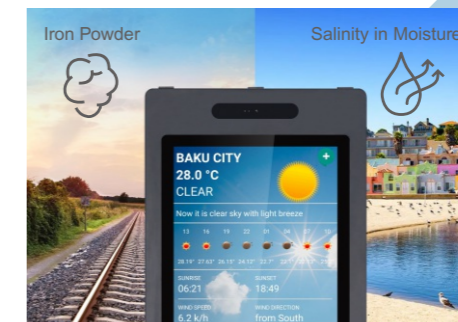

Auto Brightness

Strong Reliability

Electrical Safety

Vormatic outdoor display have electrical circuit breaker and surge suppressor. Which be sure absolute protection from overcurrent short circuits and unwanted voltages. Which helps prevent outdoor display damage and operator safety.



Supported Operating Temperature

Unique technology on LCD panel provides excellent reliability under a wide range of operating temperatures.



Protective Glass

Vormatic Outdoor display have 6mm tempered glass, with IK09/10 Endurance. Which prevent external damage and enables efficient repair.



Unique Thermal Management

This unique thermal management technology efficiently cool down the heat generated during LCD panel operating and prevent the panel heating and damage in the direct sunlight.

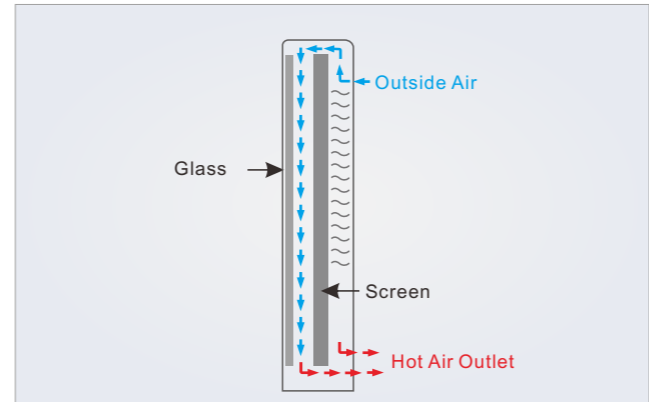

Easy Management

Door with Hydraulic stem

Open the door and access the internal conveniently.

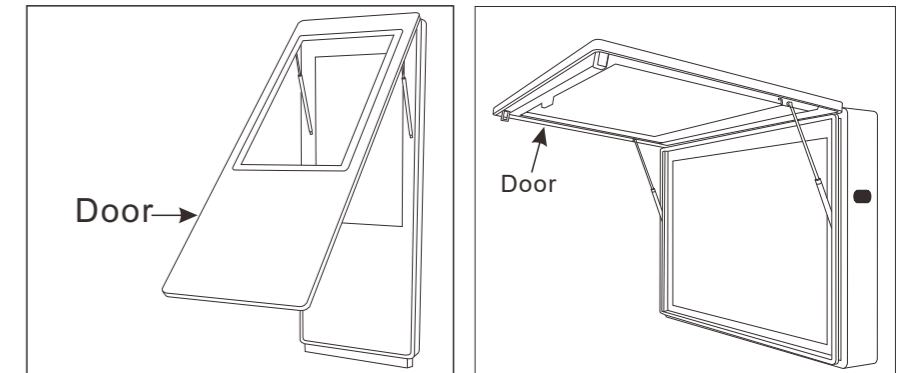

Internal technology with OPS design

Flexible OPS module allows for an instant replacement on site.

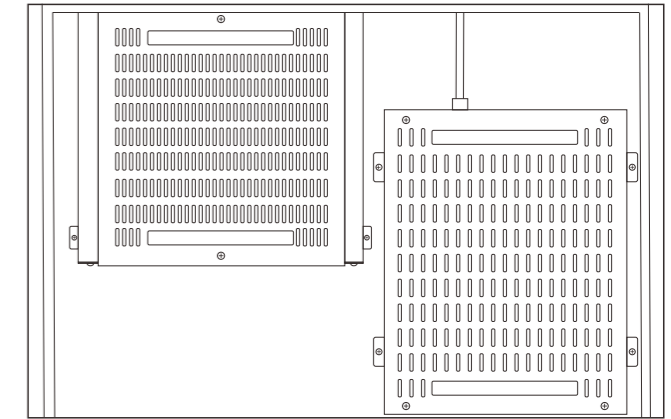

CMS Software Control

Vormatic CMS software can control and upload the contents on outdoor display remotely.



ODC SERIES

32" Wall Mounted Outdoor Sunlight Readable Display

4000 nits

PANEL SPECIFICATIONS

Model No	RCS-320ODCM
Panel Model	32inch TFT LED
Max Resolution	1920x1080
Aspect Ratio	16:09
Pixel Pitch	0.36375x0.36375
Viewing Angle	89/89/89/89
Contrast Ratio	1400:1
Brightness	4000cd/m ²
Response Time	6.5ms
Display Area (mm)	698.4x392.85
Panel Size(mm)	727.4x429x227
Screen Weight	4.8Kg
Lamp Type	WLED
Machine Weight	96.3KG
Dimensions(mm)	900x365x615
Speaker Type	10Wx2pcs
Consumption	280 W
Power Input	AC100-240V

CONNECTORS(Input)

DP	x1
HDMI	x1
VGA	x1
Audio	3.5mm Stereo Jack
ON/OFF	

ENVIRONMENTAL

Auto Cooling System	yes
Auto Heating System	yes
AG Glass Anti-UV Film	yes
Temperature Operation	- 20°C + 60°C
IP Protection	IP65

MECHANICAL

Cabinet Material	Metal
Finish	Outdoor Powder

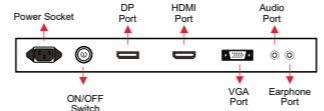
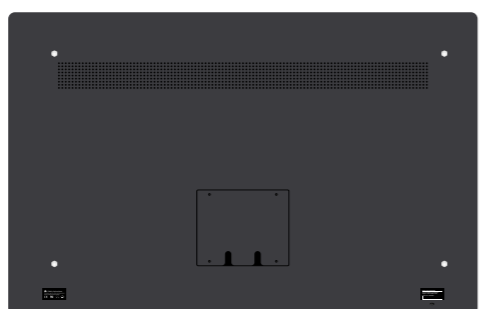
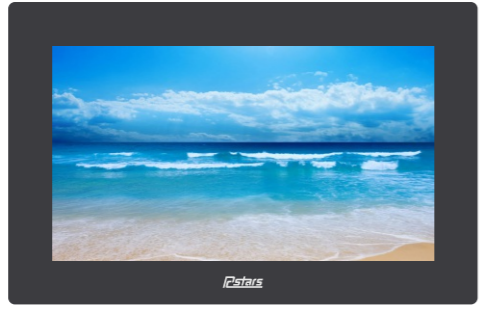

- Features**
- ※ 1920x1080 resolution
 - ※ 4000nits high brightness
 - ※ DP / HDMI / VGA Input
 - ※ Aircon for cooling and heating system
 - ※ Sunlight readable and dustproof function
 - ※ IP 65 waterproof function

ODC SERIES

55" Wall Mounted Outdoor Sunlight Readable Display

4000 nits

PANEL SPECIFICATIONS

Model No	RCS-550ODCM
Panel Model	55inch TFT LED
Max Resolution	1920x1080
Aspect Ratio	16:09
Pixel Pitch	0.63x0.63
Viewing Angle	89/89/89/89
Contrast Ratio	1400:1
Brightness	4000cd/m ²
Response Time	6ms
Display Area (mm)	1209.6x680.4mm
Panel Size(mm)	1244.6x720.9mm
Screen Weight	15Kg
Lamp Type	WLED
Machine Weight	230KG
Dimensions(mm)	1420x200x885
Speaker Type	10Wx2pcs
Consumption	530W
Power Input	AC100-240V

CONNECTORS(Input)

DP	x1
HDMI	x1
VGA	x1
Audio	3.5mm Stereo Jack
ON/OFF	

ENVIRONMENTAL

Auto Cooling System	yes
Auto Heating System	yes
AG Glass Anti-UV Film	yes
Temperature Operation	- 20°C + 60°C
IP Protection	IP65

MECHANICAL

Cabinet Material	Metal
Finish	Outdoor Powder

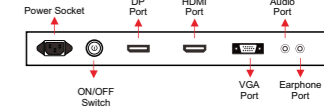
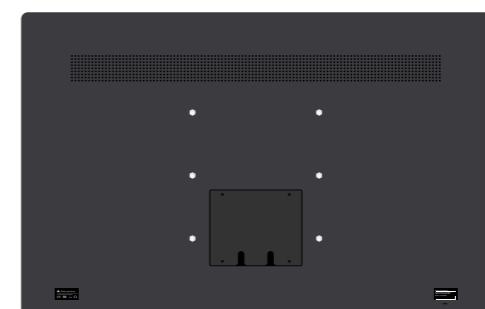
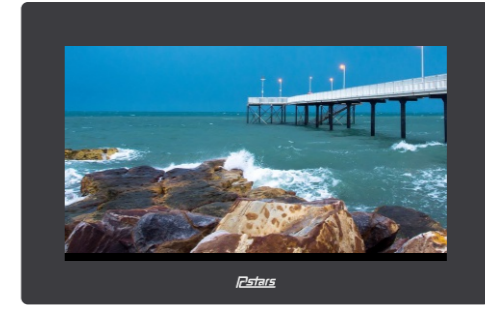

- Features**
- ※ 1920x1080 resolution
 - ※ 4000nits high brightness
 - ※ DP / HDMI / VGA Input
 - ※ Air condition for cooling and heating system
 - ※ Sunlight readable and dustproof function
 - ※ IP 65 waterproof function

ODC SERIES

65" Wall Mount Outdoor Sunlight Readable Display

4000 nits

PANEL SPECIFICATIONS	
Model No	RCS-6500DCM
Panel Model	65 inch TFT LED
Max Resolution	3840x2160
Aspect Ratio	16:09
Pixel Pitch	0.372x0.372
Viewing Angle	89/89/89/89
Contrast Ratio	1400:1
Brightness	4000cd/m ²
Response Time	13ms
Display Area (mm)	1428.48x803.52
Panel Size(mm)	1459.2x830x16
Screen Weight	22.7Kg
Lamp Type	WLED
Machine Weight	198KG
Dimensions(mm)	1640x265x965
Speaker Type	10Wx2pcs
Consumption	620 W
Power Input	AC100-240V
CONNECTORS(Input)	
DP	x1
HDMI	x1
VGA	x1
Audio	3.5mm Stereo Jack
ON/OFF	
ENVIRONMENTAL	
Auto Cooling System	yes
Auto Heating System	yes
AG Glass Anti-UV Film	yes
Temperature Operation	- 20°C + 60°C
IP Protection	IP65
MECHANICAL	
Cabinet Material	Metal
Finish	Outdoor Powder

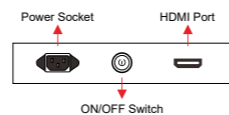
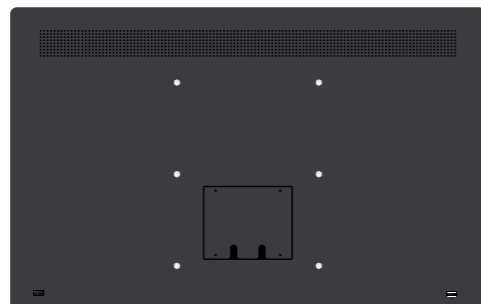
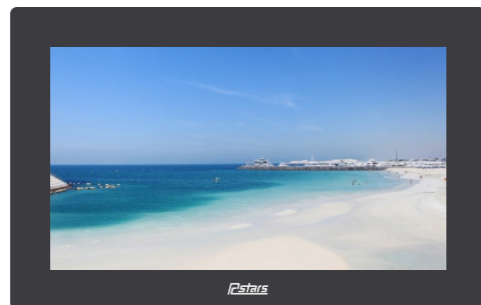

Features

- ※ 3840x2160 resolution
- ※ 4000nits high brightness
- ※ HDMI Input
- ※ Built in strong fans for cooling
- ※ Sunlight readable and dustproof function
- ※ IP65 waterproof function

ODC SERIES

86" Wall Mount Outdoor Sunlight Readable Display

4000 nits

PANEL SPECIFICATIONS	
Model No	RCS-8600DCM
Panel Model	86inch TFT LCD
Max Resolution	3840x2160
Aspect Ratio	16:09
Pixel Pitch	0.4935x0.4935
Viewing Angle	89/89/89/89
Contrast Ratio	1200:1
Brightness	4000cd/m ²
Response Time	8ms
Display Area (mm)	1895.04x1065.96
Panel Size(mm)	1922.2x1093.2x16.14
Screen Weight	42Kg
Lamp Type	WLED
Machine Weight	198KG
Dimensions(mm)	1640x265x965
Speaker Type	10Wx2pcs
Consumption	1100 W
Power Input	AC100-240V
CONNECTORS(Input)	
DP	x1
HDMI	x1
VGA	x1
Audio	3.5mm Stereo Jack
ON/OFF	
ENVIRONMENTAL	
Auto Cooling System	yes
Auto Heating System	yes
AG Glass Anti-UV Film	yes
Temperature Operation	- 20°C + 60°C
IP Protection	IP65
MECHANICAL	
Cabinet Material	Metal
Finish	Outdoor Powder

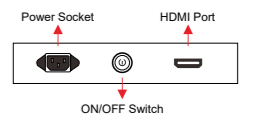
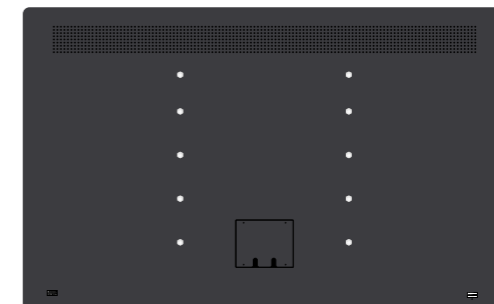
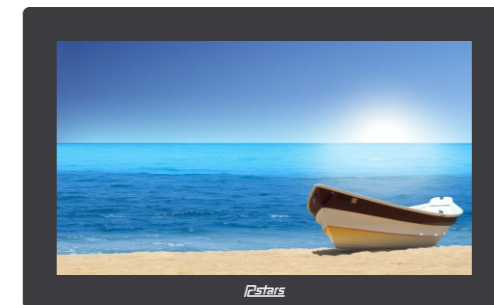

Features

- ※ 3840x2160 resolution
- ※ 4000nits high brightness
- ※ HDMI Input
- ※ Built in strong fans for cooling
- ※ Sunlight readable and dustproof function
- ※ IP65 waterproof function

ODL SERIES

43" Freestanding Sunlight Readable Outdoor Display With IP65

4000 nits

PANEL SPECIFICATIONS

Model No	RCS-430ODLM
Panel Model	43inch TFT LED
Max Resolution	1920x1080
Aspect Ratio	16:09
Pixel Pitch	0.4903x0.4903
Viewing Angle	89/89/89/89
Contrast Ratio	1200:1
Brightness	4000cd/m ²
Response Time	26ms
Display Area (mm)	941.184x592.416
Panel Size(mm)	969x563.9x26
Screen Weight	9.5Kg
Lamp Type	WLED
Machine Weight	140kg
Dimensions(mm)	1980x127x719
Speaker Type	10Wx2pcs
Consumption	240 W
Power Input	AC100-240V

CONNECTORS(Input)

DP	x1
HDMI	x1
VGA	x1
Audio	3.5mm Stereo Jack

ON/OFF

ENVIRONMENTAL

Auto Cooling System	yes
Auto Heating System	yes
AG Glass	yes
Anti-UV Film	yes
Temperature Operation	- 20°C + 60°C
IP Protection	IP65

MECHANICAL

Cabinet Material	Metal
Finish	Outdoor Powder



Features

- ※ 1920x1080 resolution
- ※ 4000nits high brightness
- ※ DP / HDMI / VGA Input
- ※ Built in air-condition for cooling
- ※ Sunlight readable and dustproof function
- ※ IP65 waterproof function

ODL SERIES

55" Freestanding Sunlight Readable Outdoor Display With IP65

4000 nits

PANEL SPECIFICATIONS

Model No	RCS-550ODLM
Panel Model	55inch TFT LED
Max Resolution	1920x1080
Aspect Ratio	16:09
Pixel Pitch	0.63x0.63
Viewing Angle	89/89/89/89
Contrast Ratio	1400:1
Brightness	4000cd/m ²
Response Time	6ms
Display Area (mm)	1209.6x680.4mm
Panel Size(mm)	1244.6x720.9mm
Screen Weight	17.5Kg
Lamp Type	WLED
Machine Weight	188kg
Dimensions(mm)	2100x127x870mm
Speaker Type	10Wx2pcs
Consumption	450 W
Power Input	AC100-240V

CONNECTORS(Input)

DP	x1
HDMI	x1
VGA	x1
Audio	3.5mm Stereo Jack

ON/OFF

ENVIRONMENTAL

Auto Cooling System	yes
Auto Heating System	yes
AG Glass	yes
Anti-UV Film	yes
Temperature Operation	- 20°C + 60°C
IP Protection	IP65

MECHANICAL

Cabinet Material	Metal
Finish	Outdoor Powder

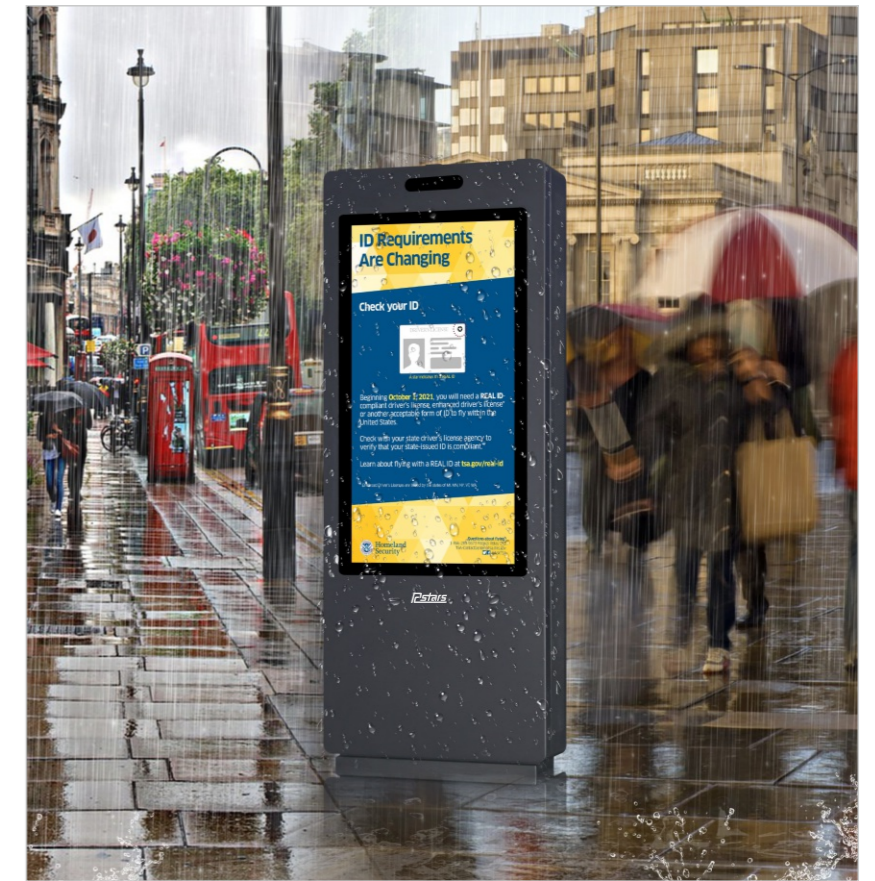

Features

- ※ 3840x2160 resolution
- ※ 4000nits high brightness
- ※ DP / HDMI / VGA Input
- ※ Built in fans for cooling
- ※ Sunlight readable and dustproof function
- ※ IP65 waterproof function

ODL SERIES

65" Freestanding Sunlight Readable Outdoor Display With IP65

4000 nits

PANEL SPECIFICATIONS	
Model No	RCS-650DLM
Panel Model	65inch TFT LED
Max Resolution	3840*2160
Aspect Ratio	16:09
Pixel Pitch	0.372×0.372
Viewing Angle	89/89/89/89
Contrast Ratio	1400:1
Brightness	4000cd/m ²
Response Time	13ms
Display Area (mm)	1428.48x803.52mm
Panel Size(mm)	1459.2x830x16mm
Screen Weight	22.7Kg
Lamp Type	WLED
Machine Weight	288kg
Dimensions(mm)	2100x127x1000mm
Speaker Type	10Wx2pcs
Consumption	680 W
Power Input	AC100-240V
CONNECTORS(Input)	
DP	x1
HDMI	x1
VGA	x1
Audio	3.5mm Stereo Jack
ON/OFF	
ENVIRONMENTAL	
Auto Cooling System	yes
Auto Heating System	yes
AG Glass	yes
Anti-UV Film	yes
Temperature Operation	- 20°C + 60°C
IP Protection	IP65
MECHANICAL	
Cabinet Material	Metal
Finish	Outdoor Powder

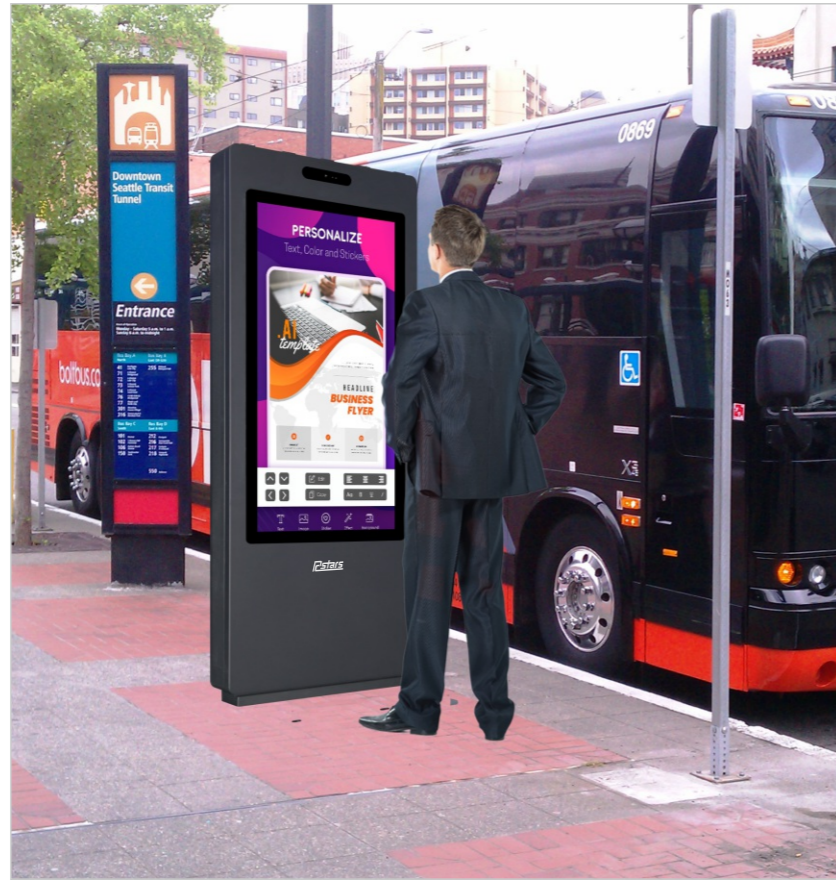

Features

- ※ 3840x2160 resolution
- ※ 4000nits high brightness
- ※ HDMI Input
- ※ Built in fans for cooling
- ※ Sunlight readable and dustproof function
- ※ IP65 waterproof function

ODL SERIES

75" Freestanding Sunlight Readable Outdoor Display With IP65

4000 nits

PANEL SPECIFICATIONS	
Model No	RCS-750DLM
Panel Model	75inch TFT LED
Max Resolution	3840x2160
Aspect Ratio	16:09
Pixel Pitch	0.4296×0.4296
Viewing Angle	89/89/89/89
Contrast Ratio	1200: 1
Brightness	2500cd/m ²
Response Time	8ms
Display Area (mm)	1549.44x871.56mm
Panel Size(mm)	1758×993×45mm
Screen Weight	28.5Kg
Lamp Type	WLED
Machine Weight	105KG
Dimensions(mm)	2480x352x1237.5
Speaker Type	10Wx2pcs
Consumption	680 W
Power Input	AC100-240V
CONNECTORS(Input)	
DP	x1
HDMI	x1
VGA	x1
Audio	3.5mm Stereo Jack
ON/OFF	
ENVIRONMENTAL	
Auto Cooling System	yes
Auto Heating System	yes
AG Glass	yes
Anti-UV Film	yes
Temperature Operation	- 20°C + 60°C
IP Protection	IP65
MECHANICAL	
Cabinet Material	Metal
Finish	Outdoor Powder



Features

- ※ 3840x2160 resolution
- ※ 4000nits high brightness
- ※ HDMI Input
- ※ Built in fans for cooling
- ※ Sunlight readable and dustproof function
- ※ IP65 waterproof function



JL SERIES
Desktop Interactive Display

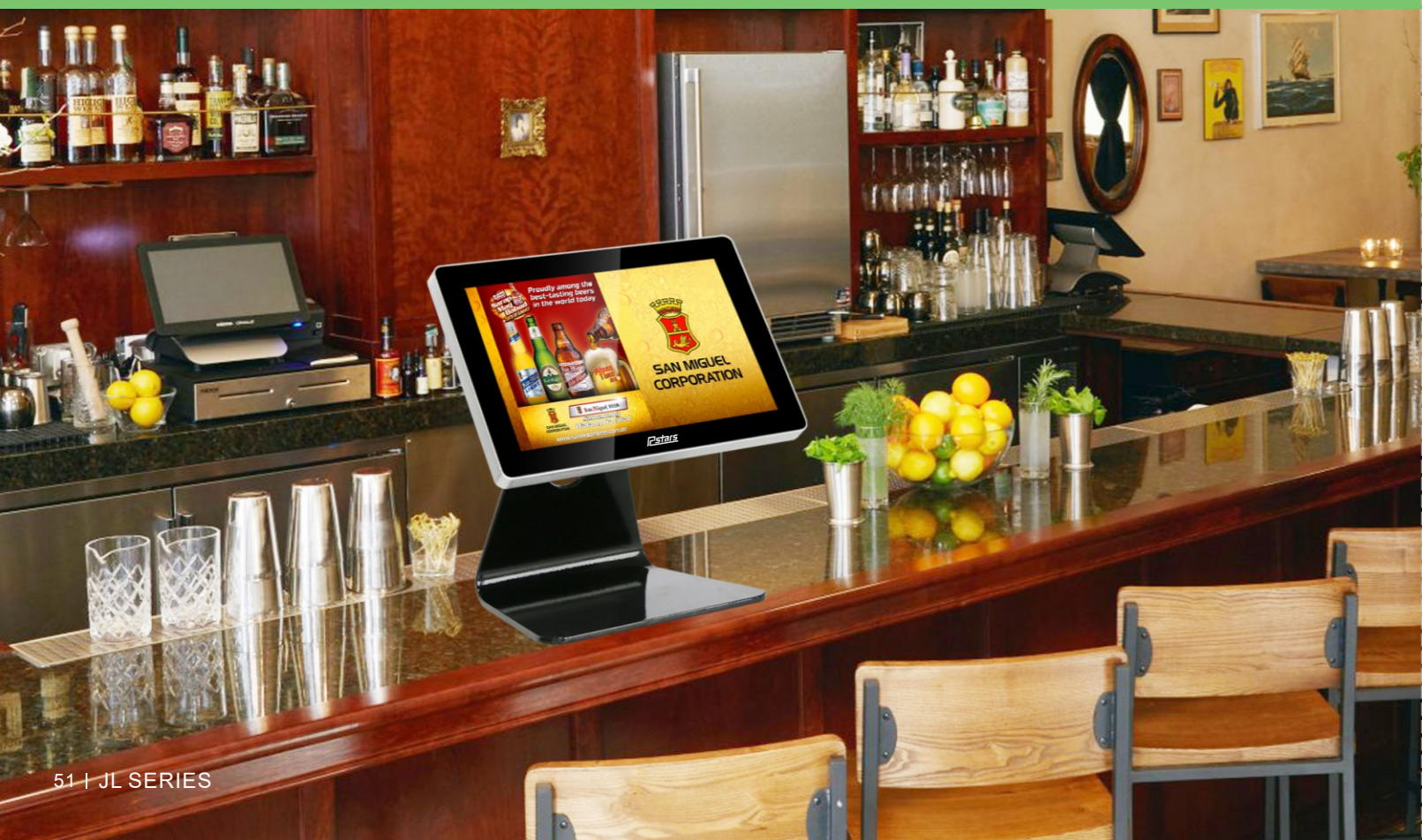

Optional size: 10.1"/15.6"/22"

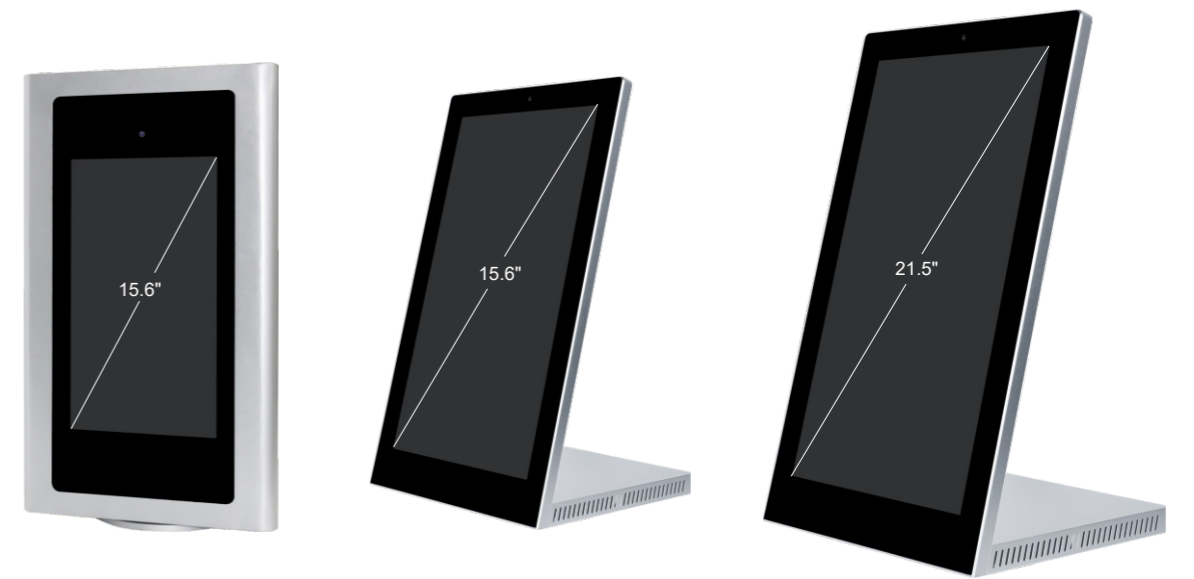

Application

- Hotel
- The coffee shop
- Jewelry store
- checkstand
- The counter
- A stage

Design/Material

- 10"-22" Optional
- Screen And Stand Could Be Removable
- Metal shell material
- Aluminum Frame With Silver Color
- Tempered Glass Protection

AZ Android Network Display

- a. Android 7.1/8.1/9.0 operating system optional
- b. RK 3288 / RK 3399 optional
- c. 2GB/4GB RAM (DDR3) optional
- d. 8GB/16GB/32GB/64GB flash optional
- e. 4G(optional)/WLAN/WiFi network connection
- f. 802.11 B/G/N Internal WiFi
- g. Portrait/landscape display mode
- h. 1080P display output
- i. Remote management software (CMS) optional

PC All-in-one Windows Display

- a. CPU: Intel® Celeron® Processor J1900 /Intel® Core® Processor I3/I5/I7
- b. Chipset: Intel Bay trail SOC /Intel® H310 Chipset
- c. System memory: 4GB/8GB RAM, 120GB/240GB SSD
- d. Input connectors: VGA/HDMI/USB/RJ45/Audio
- e. Operating system: Windows 7/8/10, Linux
- f. Preinstall Intel OS service optional

C Plug And Play Advertising Display

- a. Support picture, music and video to 1080P
- b. Support SD/HDMI/USB inputs
- c. Support SD card plug and play automatically
- d. USB update function: update documents by USB drive to SD card
- e. Support connecting with media player box/PC by HDMI input
- f. Playlist function: auto play the designated file at the specific date
- g. Timer function: 5 groups timers to turn on/off at the designated time
- h. Slideshow functions to play music and pictures at the same time
- i. Portrait/landscape display mode
- j. Scrolling text with different color and effect

M LCD Monitor

- a. Professional design for 7-24 hours operation
- b. DP/HDMI/VGA inputs
- c. Full HD resolution supported
- d. Support connecting with media player box/PC by HDMI input

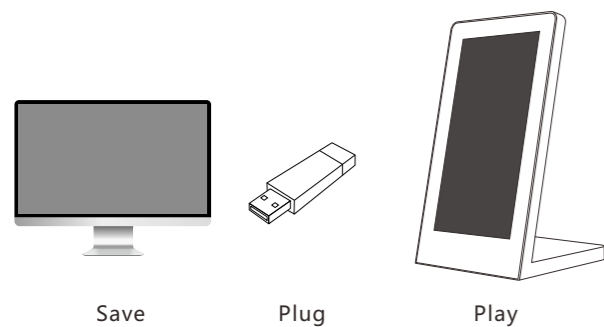
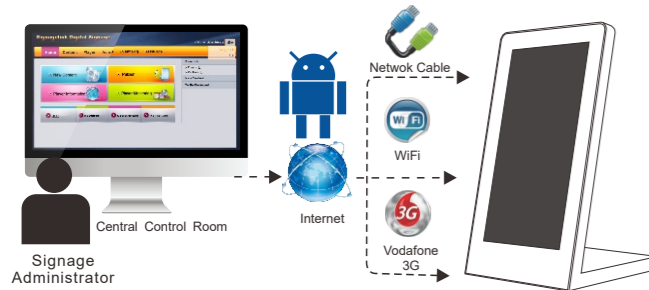

PANEL SPECIFICATIONS

Model No	RCS-220CB	RCS-240CB	RCS-320CB	RCS-430CB	RCS-490CB	RCS-550CB
	RCS-220JB	RCS-240JB	RCS-320JB	RCS-430JB	RCS-490JB	RCS-550JB
Panel Model	21.5inch TFT LED	23.6inch TFT LCD	32inch TFT LED	43inch TFT LED	49inch TFT LCD	55inch TFT LED
Max Resolution	1920x1080	1920x1080	1920x1080	1920x1080	1920x1080	1920x1080
Aspect Ratio	16:09	16:9	16:09	16:09	16:09	16:09
Pixel Pitch	0.24795x0.24795	0.2715x0.2715	0.36375x0.36375	0.4903x0.4903	0.53025x0.53025	0.63x0.63
Viewing Angle	89/89/89/89	89/89/89/89	89/89/89/89	89/89/89/89	89/89/89/89	89/89/89/89
Contrast Ratio	1000:1	3000:1	1400:1	1200:1	1000:1	1400:1
Brightness	250cd/m ²	250cd/m ²	500cd/m ²	500cd/m ²	500cd/m ²	500cd/m ²
Response Time	14ms	10ms	6.5ms	26ms	12ms	6ms
Display Area (mm)	476.064x267.786	521.28x293.22	698.4x392.85	941.184x592.416	1073.78x604	1209.6x680.4
Panel Size(mm)	495.6x292.2x10.7	544.8x320.5x11.5	727.4x429x227	973x565.8x29	1096.2x632.5x29	1244.6x720.9x27
Screen Weight	2Kg	2.3Kg	4.8Kg	11Kg	18Kg	17.5Kg
Lamp Type	WLED	WLED	WLED	WLED	WLED	WLED
Machine Weight	7KG	10.3KG	17.2KG	30.4KG	36.5KG	58KG
Dimensions(mm)	550x65x340	710x55x475	775x70x470	1050x97x630	1150x95x675	1293x79x764
Speaker Type	10Wx2pcs	10Wx2pcs	10Wx2pcs	10Wx2pcs	10Wx2pcs	10Wx2pcs
Consumption	25 W	31 W	40 W	70 W	93 W	115 W
Power Input	AC100-240V	AC100-240V	AC100-240V	AC100-240V	AC100-240V	AC100-240V
Media Players	Android System / Windows System / Plug&play System / Monitor					
Mechanical	Cabinet Material	Body: Metal case; Base: Metal				
Extended function	Touch	IR Touch / Capacitive (PCAP) Touch				
	Motion Sensor	Optional				
	High Brightness	Normal/500nits/1000nits/1500nits/2000nits optional				
Accessories	Remote Control, Power supply, User manual, Keys, Tools and Screws					

JL Series case





D SERIES
Ultra Slim Free Standing LCD Monitor



Optional size: 32"/43"/55"/65"/75"

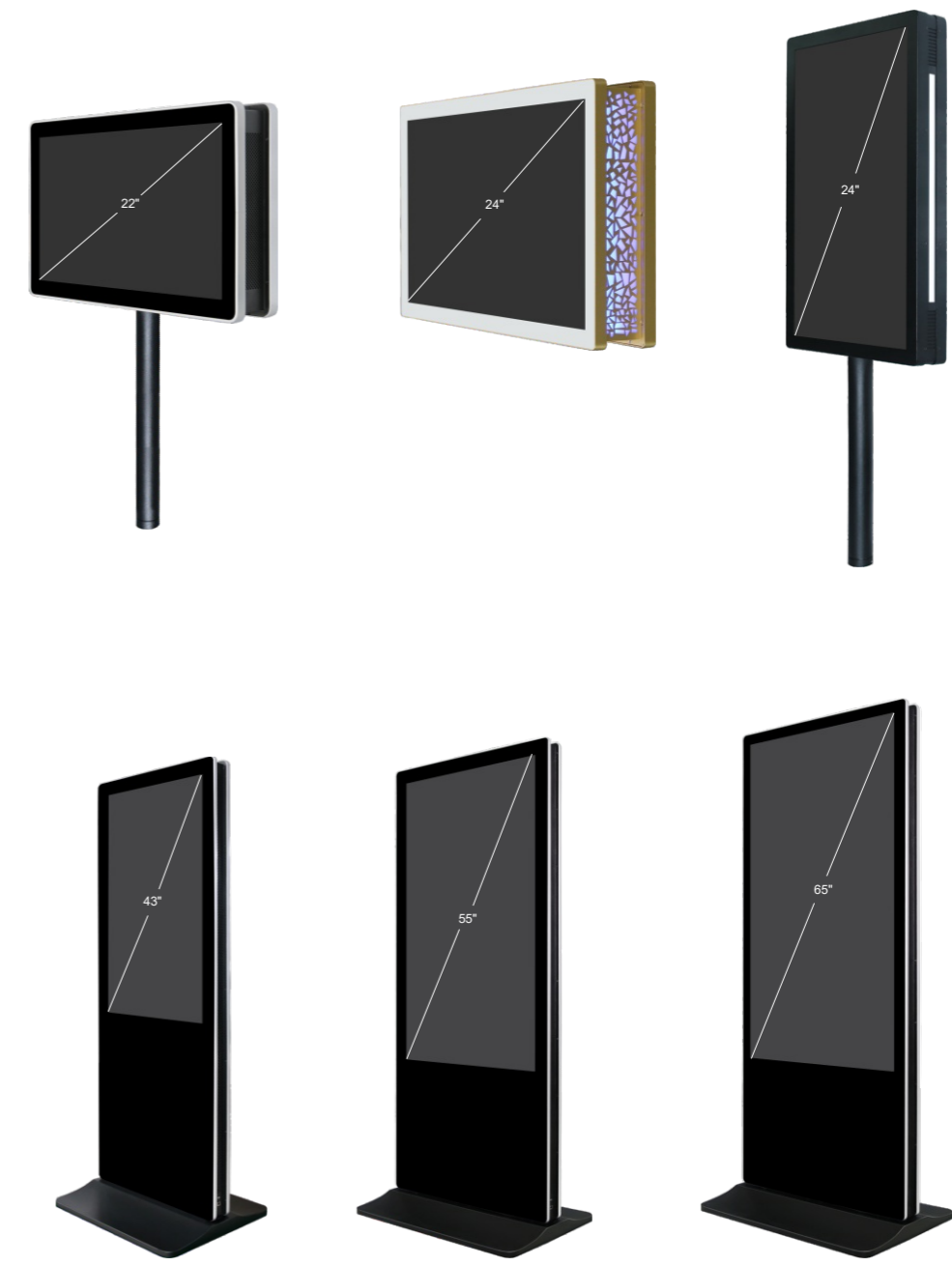

Application

- Security
- Transportation
- ATM Machine
- Medical Equipment
- Gaming Machine
- Networking POS
- General Application

Design/Material

- 22"-75" Optional
- Tempered Glass Protection
- Aluminum Frame With Silver Color
- 40mm Thickness Design
- Infrared Touch/Capacitive Touch Optional

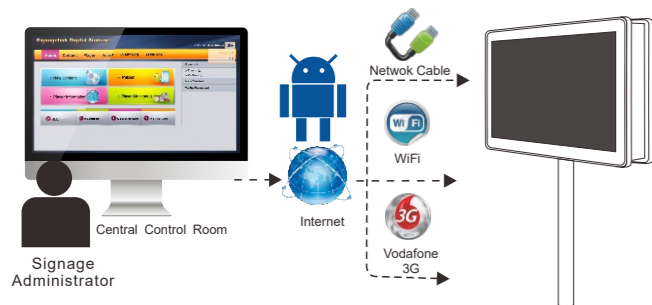

AZ Android Network Display

- a. Android 7.1/8.1/9.0 operating system optional
- b. RK 3288 / RK 3399 optional
- c. 2GB/4GB RAM (DDR3) optional
- d. 8GB/16GB/32GB/64GB flash optional
- e. 4G(optional)/WLAN/WiFi network connection
- f. 802.11 B/G/N Internal WiFi
- g. Portrait/landscape display mode
- h. 1080P display output
- i. Remote management software (CMS) optional

PC All-in-one Windows Display

- a. CPU: Intel® Celeron® Processor J1900 /Intel® Core® Processor I3/I5/I7
- b. Chipset: Intel Bay trail SOC /Intel® H310 Chipset
- c. System memory: 4GB/8GB RAM, 120GB/240GB SSD
- d. Input connectors: VGA/HDMI/USB/RJ45/Audio
- e. Operating system: Windows 7/8/10, Linux
- f. Preinstall Intel OS service optional

C Plug And Play Advertising Display

- a. Support picture, music and video to 1080P
- b. Support SD/HDMI/USB inputs
- c. Support SD card plug and play automatically
- d. USB update function: update documents by USB drive to SD card
- e. Support connecting with media player box/PC by HDMI input
- f. Playlist function: auto play the designated file at the specific date
- g. Timer function: 5 groups timers to turn on/off at the designated time
- h. Slideshow functions to play music and pictures at the same time
- i. Portrait/landscape display mode
- j. Scrolling text with different color and effect

M LCD Monitor

- a. Professional design for 7-24 hours operation
- b. DP/HDMI/VGA inputs
- c. Full HD resolution supported
- d. Support connecting with media player box/PC by HDMI input

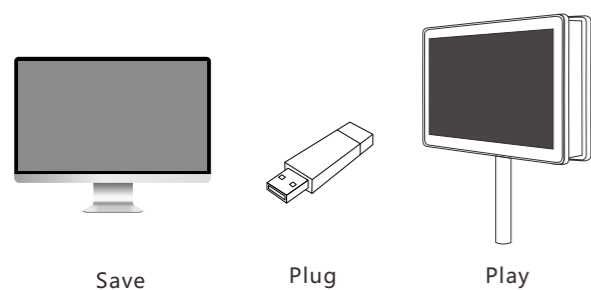

PANEL SPECIFICATIONS

Model No	RCS-220D	RCS-240D	RCS-320D	RCS-430D	RCS-490D	RCS-550D
	RCS-220JB	RCS-240JB	RCS-320JB	RCS-430JB	RCS-490JB	RCS-550JB
Panel Model	21.5inch TFT LED	23.6inch TFT LCD	32inch TFT LED	43inch TFT LED	49inch TFT LCD	55inch TFT LED
Max Resolution	1920x1080	1920x1080	1920x1080	1920x1080	1920x1080	1920x1080
Aspect Ratio	16:09	16:9	16:09	16:09	16:09	16:09
Pixel Pitch	0.24795×0.24795	0.2715×0.2715	0.36375×0.36375	0.4903×0.4903	0.53025×0.53025	0.63×0.63
Viewing Angle	89/89/89/89	89/89/89/89	89/89/89/89	89/89/89/89	89/89/89/89	89/89/89/89
Contrast Ratio	1000:1	3000:1	1400:1	1200:1	1000:1	1400:1
Brightness	250cd/m ²	250cd/m ²	500cd/m ²	500cd/m ²	500cd/m ²	500cd/m ²
Response Time	14ms	10ms	6.5ms	26ms	12ms	6ms
Display Area (mm)	476.064x267.786	521.28x293.22	698.4x392.85	941.184x592.416	1073.78x604	1209.6x680.4
Panel Size(mm)	495.6x292.2x10.7	544.8x320.5x11.5	727.4x429x227	973x565.8x29	1096.2x632.5x29	1244.6x720.9x27
Screen Weight	2Kg	2.3Kg	4.8Kg	11Kg	18Kg	17.5Kg
Lamp Type	WLED	WLED	WLED	WLED	WLED	WLED
Machine Weight	7KG	10.3KG	17.2KG	30.4KG	36.5KG	58KG
Dimensions(mm)	550x65x340	710x55x475	775x70x470	1050x97x630	1150x95x675	1293x79x764
Speaker Type	10Wx2pcs	10Wx2pcs	10Wx2pcs	10Wx2pcs	10Wx2pcs	10Wx2pcs
Consumption	25 W	31 W	40 W	70 W	93 W	115 W
Power Input	AC100-240V	AC100-240V	AC100-240V	AC100-240V	AC100-240V	AC100-240V
Media Players	Android System / Windows System / Plug&play System / Monitor					
Mechanical	Cabinet Material	Body: Metal case; Base: Metal				
Extended function	Touch	IR Touch / Capacitive (PCAP) Touch				
	Motion Sensor	Optional				
	High Brightness	Normal/500nits/1000nits/1500nits/2000nits optional				
Accessories	Remote Control, Power supply, User manual, Keys, Tools and Screws					

CB Series case



24" Double-sided LCD Monitor for Gambling and Casino

PANEL SPECIFICATIONS	
Model No	RCS-240DJM
Panel Model	23.6inch TFT LCD
Max Resolution	1920x1080
Aspect Ratio	16:9
Pixel Pitch	0.2715x0.2715
Viewing Angle	89/89/89/89
Contrast Ratio	3000:1
Brightness	250cd/m ²
Response Time	10ms
Display Area (mm)	521.28x293.22
Panel Size(mm)	544.8x320.5x11.5
Screen Weight	2.3Kg
Lamp Type	WLED
Machine Weight	12 KG
Dimensions(mm)	562.5x103x326.5
Speaker Type	10Wx2pcs
Consumption	31 W
Power Input	DC12V
CONNECTORS(Input)	
DP	X1
HDMI	X1
VGA	X1
DC	X1
ON/OFF	X1
MECHANICAL	
Cabinet Material	Metal
Finish	Gold



Features

- ※ Portrait and landscape are optional
- ※ RCS-240CM-D is the OEM model for casino
- ※ It can be designed to be double sided & single sided
- ※ And LED light design on the side is available for catching the clients eyes
- ※ Display with full HD resolution 1920*1080
- ※ Providing viewing angle with 89/89/89/89
- ※ Heat dissipation design

24" All In One Windows Display With 80mm Printer

PANEL SPECIFICATIONS	
Model No	RCS-240DM
Panel Model	23.8inch TFT LED
Max Resolution	1920x1080
Aspect Ratio	16:9
Pixel Pitch	0.2745x0.2745
Viewing Angle	89/89/89/89
Contrast Ratio	1000:1
Brightness	250cd/m ²
Response Time	15ms
Display Area (mm)	527.04x296.46
Panel Size(mm)	543x317.4x11.6
Screen Weight	2.27Kg
Lamp Type	WLED
Machine Weight	8.6KG
Dimensions(mm)	590x65x370
Speaker Type	10Wx2pcs
Consumption	36 W
Power Input	AC100-240V
CONNECTORS	
USB 2.0	X4
HDMI (Output)	X1
AC	X1
Rj45	X1
VGA (Output)	X1
ON/OFF	X1
MECHANICAL	
Cabinet Material	Metal
Finish	White



Features

- ※ CPU: Intel® Core® Processor, I3 5010U (Dual core four thread, 3M L3 Cache, 2.1GHz)
- ※ Chipset: Haswell-U
- ※ Graphic Card: Intel HD5500
- ※ Memory: 4GB RAM, 120G SSD
- ※ Audio: Realtek ALC662
- ※ Ethernet LAN: 1*RTL8111E LAN
- ※ EPSON Brand 80mm Thermal Printer
- ※ Capacitive Touch

55" Double Side Android OS LCD Kiosk

PANEL SPECIFICATIONS	
Model No	RCS-550DLAZ
Panel Model	55inch TFT LED
Max Resolution	1920x1080
Aspect Ratio	16:09
Pixel Pitch	0.63x0.63
Viewing Angle	89/89/89/89
Contrast Ratio	1400:1
Brightness	500cd/m ²
Response Time	6ms
Display Area (mm)	1209.6x680.4
Panel Size(mm)	1244.6x720.9x27
Screen Weight	17.5Kg
Lamp Type	WLED
Machine Weight	30.9KG
Dimensions(mm)	1269.5x749x62
Speaker Type	10Wx2pcs
Consumption	115 W
Power Input	AC100-240V
CONNECTORS	
USB 2.0	X2
HDMI (Output)	X1
SD	X1
Rj45	X1
4G SIM (Optional)	X1
ON/OFF	X1
MECHANICAL	
Cabinet Material	Metal
Finish	Black



Features

- ※. Android 7.1/8.1/9.0 operating system optional
- ※. RK 3288 / RK 3399 optional
- ※. 2GB/4GB RAM (DDR3) optional
- ※. 8GB/16GB/32GB/64GB flash optional
- ※. 4G(optional)/WLAN/WiFi network connection
- ※. 802.11 B/G/N Internal WiFi
- ※. Portrait/landscape display mode
- ※. 1080P display output
- ※. Remote management software (CMS) optional
- ※. Capacitive touch/IR touch screen optional

55" Double Side Android OS LCD Kiosk

PANEL SPECIFICATIONS	
Model No	RCS-550DLAZ
Panel Model	55inch TFT LED
Max Resolution	1920x1080
Aspect Ratio	16:09
Pixel Pitch	0.63x0.63
Viewing Angle	89/89/89/89
Contrast Ratio	1400:1
Brightness	500cd/m ²
Response Time	6ms
Display Area (mm)	1209.6x680.4
Panel Size(mm)	1244.6x720.9x27
Screen Weight	17.5Kg
Lamp Type	WLED
Machine Weight	30.9KG
Dimensions(mm)	1269.5x749x62
Speaker Type	10Wx2pcs
Consumption	115 W
Power Input	AC100-240V
CONNECTORS	
USB 2.0	X2
HDMI (Output)	X1
SD	X1
Rj45	X1
4G SIM (Optional)	X1
ON/OFF	X1
MECHANICAL	
Cabinet Material	Metal
Finish	White

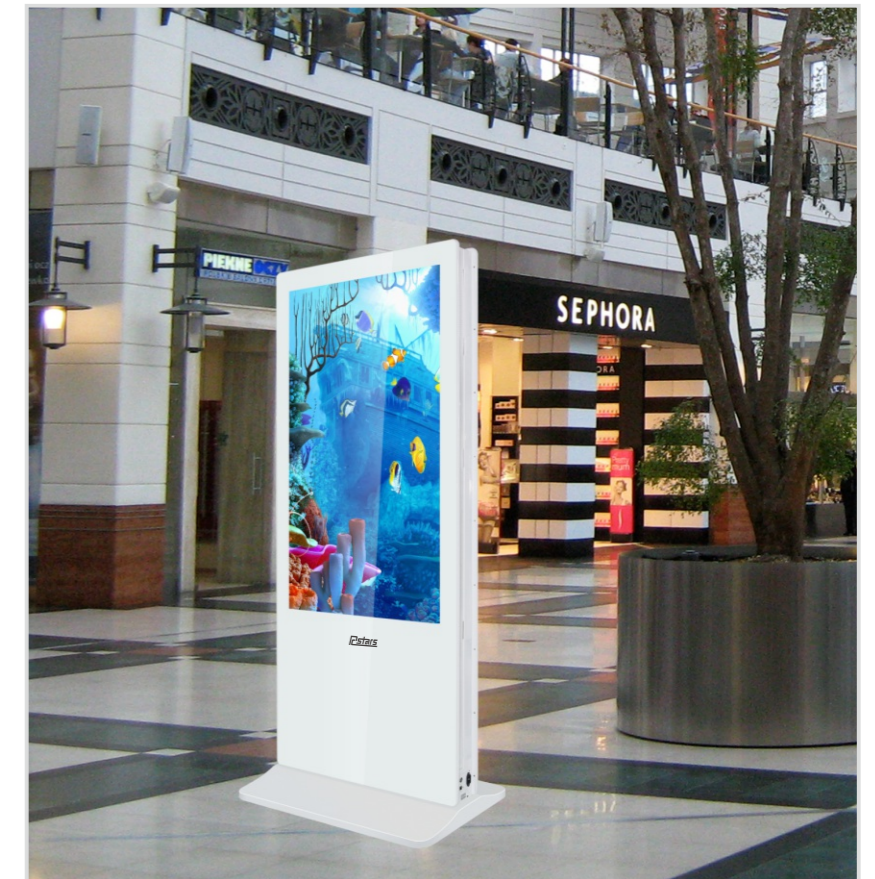

Features

- ※. Android 7.1/8.1/9.0 operating system optional
- ※. RK 3288 / RK 3399 optional
- ※. 2GB/4GB RAM (DDR3) optional
- ※. 8GB/16GB/32GB/64GB flash optional
- ※. 4G(optional)/WLAN/WiFi network connection
- ※. 802.11 B/G/N Internal WiFi
- ※. Portrait/landscape display mode
- ※. 1080P display output
- ※. Remote management software (CMS) optional
- ※. Capacitive touch/IR touch screen optional



OEM/ODM SERIES

Customized Products



OEM/ODM Service

Hardware Design



LOGO Design

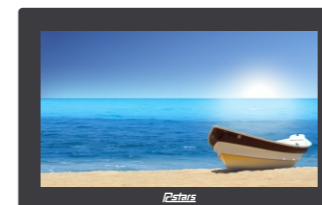

Silkscreen Logo

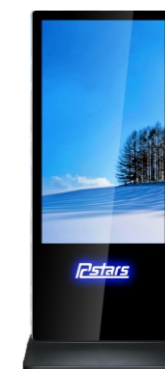

LED Lighting Logo



Opening Logo Background

OEM Color

Software custom-design



21.5"/32" Freestanding Touch Android LCD Display with Book Holder

PANEL SPECIFICATIONS	
Model No	RCS-220LBTAZ-PCAP
Panel Model	21.5inch TFT LED
Max Resolution	1920x1080
Aspect Ratio	16:09
Pixel Pitch	0.24795x0.24795
Viewing Angle	89/89/89/89
Contrast Ratio	1000:1
Brightness	250cd/m ²
Response Time	14ms
Display Area (mm)	476.064x267.786mm
Panel Size(mm)	495.6x292.2x10.7mm
Screen Weight	2Kg
Lamp Type	WLED
Machine Weight	24.5KG
Dimensions(mm)	1580x38x370
Speaker Type	10Wx2pcs
Consumption	25 W
Power Input	AC 100-240V
CONNECTORS	
USB 2.0	X2
HDMI (Output)	X1
SD	X1
Rj45	X1
4G SIM (Optional)	X1
ON/OFF	X1
MECHANICAL	
Cabinet Material	Metal
Finish	Black



Features

- ※. Android 7.1/8.1/9.0 operating system optional
- ※. RK 3288 / RK 3399 optional
- ※. 2GB/4GB RAM (DDR3) optional
- ※. 8GB/16GB/32GB/64GB flash optional
- ※. 4G(optional)/WLAN/WiFi network connection
- ※. 802.11 B/G/N Internal WiFi
- ※. Portrait/landscape display mode
- ※. 1080P display output
- ※. Remote management software (CMS) optional
- ※. Capacitive touch
- ※. Newspaper shelves

24"/32" Android Capacitive Touch LCD Display

PANEL SPECIFICATIONS	
Model No	RCS-240GITAZ-PCAP
Panel Model	23.8inch TFT LED
Max Resolution	1920x1080
Aspect Ratio	16:9
Pixel Pitch	0.2745x0.2745
Viewing Angle	89/89/89/89
Contrast Ratio	1000:1
Brightness	300cd/m ²
Response Time	15ms
Display Area (mm)	527.04x296.46
Panel Size(mm)	543x317.4x11.6
Screen Weight	2.27Kg
Lamp Type	WLED
Machine Weight	19.3KG
Dimensions(mm)	707x41x475
Speaker Type	10Wx2pcs
Consumption	31 W
Power Input	AC 100-240V
CONNECTORS	
USB 2.0	X2
HDMI (Output)	X1
SD	X1
Rj45	X1
4G SIM (Optional)	X1
ON/OFF	X1
MECHANICAL	
Cabinet Material	Metal
Finish	White



Features

- ※. Android 7.1/8.1/9.0 operating system optional
- ※. RK 3288 / RK 3399 optional
- ※. 2GB/4GB RAM (DDR3) optional
- ※. 8GB/16GB/32GB/64GB flash optional
- ※. 4G(optional)/WLAN/WiFi network connection
- ※. 802.11 B/G/N Internal WiFi
- ※. Portrait/landscape display mode
- ※. 1080P display output
- ※. Remote management software (CMS) optional
- ※. Capacitive touch

24" All In One Windows Display With 80mm Printer

PANEL SPECIFICATIONS	
Model No	RCS-240CKTPC-PCAP-P
Panel Model	23.8inch TFT LED
Max Resolution	1920x1080
Aspect Ratio	16:9
Pixel Pitch	0.2745x0.2745
Viewing Angle	89/89/89/89
Contrast Ratio	1000:1
Brightness	250cd/m ²
Response Time	15ms
Display Area (mm)	527.04x296.46
Panel Size(mm)	543x317.4x11.6
Screen Weight	2.27Kg
Lamp Type	WLED
Machine Weight	8.6KG
Dimensions(mm)	590x65x370
Speaker Type	10Wx2pcs
Consumption	36 W
Power Input	AC100-240V
CONNECTORS	
USB 2.0	X4
HDMI (Output)	X1
AC	X1
Rj45	X1
VGA (Output)	X1
ON/OFF	X1
MECHANICAL	
Cabinet Material	Metal
Finish	White



80mm Thermal Printer

Features

- ※ CPU: Intel® Core® Processor, I3 5010U (Dual core four thread, 3M L3 Cache, 2.1GHz)
- ※ Chipset: Haswell-U
- ※ Graphic Card: Intel HD5500
- ※ Memory: 4GB RAM, 120G SSD
- ※ Audio: Realtek ALC662
- ※ Ethernet LAN: 1*RTL8111E LAN
- ※ EPSON Brand 80mm Thermal Printer
- ※ Capacitive Touch

10.1" Wall Cabinet Android LCD Display with POE

PANEL SPECIFICATIONS	
Model No	RCS-101CAZ-POE
Panel Model	10.1inch TFT LED
Max Resolution	1280x800
Aspect Ratio	16:10
Pixel Pitch	0.1659x0.1659
Viewing Angle	85/85/85/85
Contrast Ratio	1300:1
Brightness	350cd/m ²
Response Time	25ms
Display Area (mm)	216.96x135.60
Panel Size(mm)	241.86x161.6x5.2
Screen Weight	180g
Lamp Type	WLED
Machine Weight	0.9KG
Dimensions(mm)	297.8x48x216.5
Speaker Type	5Wx2pcs
Consumption	12 W
Power Input	DC 12V
CONNECTORS	
USB 2.0	X2
HDMI (Output)	X1
SD	X1
Rj45	X1
4G SIM (Optional)	X1
ON/OFF	X1
MECHANICAL	
Cabinet Material	Metal
Finish	Black



Features

- ※ 10.1" 1280x800 IPS panel
- ※ Android operating system
- ※ with POE
- ※ Embedded in wall
- ※ Tempered glass protection for the screen
- ※ Easy to get out of the wall

15.6"/21.5" Interactive Tablet Android Display

PANEL SPECIFICATIONS		
Model No	RCS-151JITAZ-PCAP	RCS-220JITAZ-PCAP
Panel Model	15.6inch TFT LCD	21.5inch TFT LED
Max Resolution	1920x1080	1920x1080
Aspect Ratio	16:09	16:09
Pixel Pitch	0.17925×0.17925	0.24795×0.24795
Viewing Angle	85/85/85/85	89/89/89/89
Contrast Ratio	700:1	1000:1
Brightness	300cd/m ²	250cd/m ²
Response Time	25ms	14ms
Display Area (mm)	344.16x193.59	476.064x267.786mm
Panel Size(mm)	359.5x223.8x3.2	495.6x292.2x10.7mm
Screen Weight	1.2kg	2Kg
Lamp Type	WLED	WLED
Machine Weight	21.1KG	23KG
Dimensions(mm)	1317x275x350	1373x330x400
Speaker Type	5Wx2pcs	5Wx2pcs
Consumption	16 W	25 W
Power Input	DC 12V	AC 100-240V
CONNECTORS		
USB 2.0	X2	X2
HDMI (Output)	X1	X1
SD	X1	X1
Rj45	X1	X1
4G SIM (Optional)	X1	X1
ON/OFF	X1	X1
MECHANICAL		
Cabinet Material	Metal	Metal
Finish	Black	Black



Features

- ※. Android 7.1/8.1/9.0 operating system optional
- ※. RK 3288 / RK 3399 optional
- ※. 2GB/4GB RAM (DDR3) optional
- ※. 8GB/16GB/32GB/64GB flash optional
- ※. 4G(optional)/WLAN/WiFi network connection
- ※. 802.11 B/G/N Internal WiFi
- ※. Remote management software (CMS) optional
- ※ 10 Points Capacitive Touch

43" Ultra-thin Network LCD Digital Poster

PANEL SPECIFICATIONS	
Model No	RCS-430LAAZ
Panel Model	43inch TFT LED
Max Resolution	1920x1080
Aspect Ratio	16:09
Pixel Pitch	0.4903×0.4903
Viewing Angle	89/89/89/89
Contrast Ratio	1200:1
Brightness	500cd/m ²
Response Time	26ms
Display Area (mm)	941.184x592.416
Panel Size(mm)	973x565.8x29
Screen Weight	11Kg
Lamp Type	WLED
Machine Weight	23.4KG
Dimensions(mm)	998.4x593x57.5
Speaker Type	10Wx2pcs
Consumption	70 W
Power Input	AC100-240V
CONNECTORS	
USB 2.0	X2
HDMI (Output)	X1
SD	X1
Rj45	X1
4G SIM (Optional)	X1
ON/OFF	X1
MECHANICAL	
Cabinet Material	Metal
Finish	White



Features

- ※. Android 7.1/8.1/9.0 operating system optional
- ※. RK 3288 / RK 3399 optional
- ※. 2GB/4GB RAM (DDR3) optional
- ※. 8GB/16GB/32GB/64GB flash optional
- ※. 4G(optional)/WLAN/WiFi network connection
- ※. 802.11 B/G/N Internal WiFi
- ※. Portrait/landscape display mode
- ※. 1080P display output
- ※. Remote management software (CMS) optional
- ※ Capacitive touch/IR touch screen optional

21.5" Android LCD Hand Sanitizer Display & Kiosk

PANEL SPECIFICATIONS	
Model No	RCS-220SDUAZ
Panel Model	21.5inch TFT LED
Max Resolution	1920x1080
Aspect Ratio	16:09
Pixel Pitch	0.24795x0.24795
Viewing Angle	89/89/89/89
Contrast Ratio	1000:1
Brightness	250cd/m ²
Response Time	14ms
Display Area (mm)	476.064x267.786mm
Panel Size(mm)	495.6x292.2x10.7mm
Screen Weight	2Kg
Lamp Type	WLED
Machine Weight	23KG
Dimensions(mm)	940x320x620mm
Speaker Type	5Wx2pcs
Consumption	30 W
Power Input	AC 100-240V
CONNECTORS	
USB 2.0	X2
HDMI (Output)	X1
SD	X1
Rj45	X1
4G SIM (Optional)	X1
ON/OFF	X1
MECHANICAL	
Cabinet Material	Metal
Finish	Black / White



Features

- ※. Android 7.1/8.1/9.0 operating system optional
- ※. RK 3288 / RK 3399 optional
- ※. 2GB/4GB RAM (DDR3) optional
- ※. 8GB/16GB/32GB/64GB flash optional
- ※. 4G(optional)/WLAN/WiFi network connection
- ※. 802.11 B/G/N Internal WiFi
- ※. Portrait/landscape display mode
- ※. 1080P display output
- ※. Remote management software (CMS) optional
- ※. 10 Points Capacitive Touch

21.5" /32" Self Order Service Kiosk

PANEL SPECIFICATIONS		
Model No	RCS-220YOTM-PCAP	RCS-320YOTM-PCAP
Panel Model	21.5inch TFT LED	32inch TFT LED
Max Resolution	1920x1080	1920x1080
Aspect Ratio	16:09	16:09
Pixel Pitch	0.24795x0.24795	0.36375x0.36375
Viewing Angle	89/89/89/89	89/89/89/89
Contrast Ratio	1000:1	1400:1
Brightness	250cd/m ²	500cd/m ²
Response Time	14ms	6.5ms
Display Area (mm)	476.064x267.786mm	698.4x392.85mm
Panel Size(mm)	495.6x292.2x10.7mm	727.4x429x227mm
Screen Weight	2Kg	4.8Kg
Lamp Type	WLED	WLED
Machine Weight	23KG	21.1KG
Dimensions(mm)	871.4x171.2x384.5	1115.7x135x529
Speaker Type	5Wx2pcs	5Wx2pcs
Consumption	30 W	40 W
Power Input	AC 100-240V	AC 100-240V
CONNECTORS(Input)		
VGA	X1	X1
HDMI	X2	X2
AC	X1	X1
ON/OFF	X1	X1
MECHANICAL		
Cabinet Material	Metal	Metal
Finish	Black / White	Black / White



Features

- 32 inch Self Order Service Kiosk
- 1920x1080 resolution
- 89/89/89/89 viewing angle
- DP / HDMI / VGA input
- 7-24 hours operation
- Standard 100x100MM Vesa Holes
- 2 High Quality Speakers
- Capacitive Touch
- Camera Optional
- Thermal Printer
- QR Reader Scanner
- POS

43" Double sided Android Network Digital Signage

PANEL SPECIFICATIONS	
Model No	RCS-430SWAZ
Panel Model	43inch TFT LED
Max Resolution	1920x1080
Aspect Ratio	16:09
Pixel Pitch	0.4903x0.4903
Viewing Angle	89/89/89/89
Contrast Ratio	1200:1
Brightness	500cd/m ²
Response Time	26ms
Display Area (mm)	941.184x592.416
Panel Size(mm)	973x565.8x29
Screen Weight	11Kg
Lamp Type	WLED
Machine Weight	23.4KG
Dimensions(mm)	1133.6x49.5x579
Speaker Type	5Wx2pcs
Consumption	70 W
Power Input	AC100-240V
CONNECTORS	
USB 2.0	X2
HDMI (Output)	X1
SD	X1
Rj45	X1
4G SIM (Optional)	X1
ON/OFF	X1
MECHANICAL	
Cabinet Material	Metal
Finish	Black / White



Features

- ※. Android 7.1/8.1/9.0 operating system optional
- ※. RK 3288 / RK 3399 optional
- ※. 2GB/4GB RAM (DDR3) optional
- ※. 8GB/16GB/32GB/64GB flash optional
- ※. 4G(optional)/WLAN/WiFi network connection
- ※. 802.11 B/G/N Internal WiFi
- ※. Remote management software (CMS) optional
- ※. Capacitive touch/IR touch screen optional

23.6" LCD Screen

PANEL SPECIFICATIONS	
Model No	RCS-236CRAZ
Panel Model	23.6 inch LCD
Max Resolution	848x848 35PPI
Aspect Ratio	1:1
Pixel Pitch	0.708x0.708
Viewing Angle	89/89/89/89
Contrast Ratio	4000:01:00
Brightness	700cd/m ²
Response Time	1/8ms
Display Area (mm)	600.384(H)x600.384(V)
Panel Size(mm)	663.781x663.781mm
Screen Weight	TBD
Lamp Type	TFT-LCD
Machine Weight	21.5KG
Dimensions(mm)	800x760x63
Speaker Type	5Wx2pcs
Consumption	63 W
Power Input	AC100-240V
CONNECTORS	
USB 2.0	X1
HDMI (Input)	X1
DP	X2
ON/OFF	X1
MECHANICAL	
Cabinet Material	Metal
Finish	Black / White



Features

- ※. Android 7.1/8.1/9.0 operating system optional
- ※. RK 3288 / RK 3399 optional
- ※. 2GB/4GB RAM (DDR3) optional
- ※. 8GB/16GB/32GB/64GB flash optional
- ※. 4G(optional)/WLAN/WiFi network connection
- ※. 802.11 B/G/N Internal WiFi
- ※. Portrait/landscape display mode
- ※. Remote management software (CMS) optional
- ※. Capacitive touch/IR touch screen optional

Android Media Player Box (RCS-903AZ)

SPECIFICATION	
CPU	Rockchip RK3288 Quad Core
RAM	1/2GB DDR3
Flash	8GB Flash (up to 32GB)
Operating System	Android 7.1 / 8.1 / 9.0
Output Interface	HDMI
Audio	MP3,WMA,WAV,EAAC+, MP2 dec, Vorbis (Ogg), Ac3, FLAC, APE...
Video	H.264, MKV, WMV9, MPEG 1/2/4, HD Divx, Xvid, RM/RMVB;
Photo Format	BMP/PNG/GIF/JPEG
Ethernet	10/100 MBit compatible interface
WIFI	802.11 a/b/g/n
USB	2*USB 2.0 Host
Card Reader	SD/MMC/3G Slim
Power Adaptor	12VDC
Consumption	8 W
Machine Weight	0.5KG
Dimensions(mm)	218x45x140
Packaging (mm)	430x372x325
INTERFACE	DESCRIPTION
1	HDMI Output High-definition signal output
2	USB Host Mouse connection
3	RJ45 Network connection
4	SD Card Memory card MS.SD.MMC
5	4G Sim Card Support 4G Sim card
6	Remote Sensor Remote controller sensor

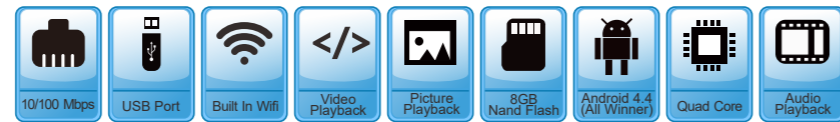

Features

- ※. Android 7.1/8.1/9.0 operating system optional
- ※. RK 3288 / RK 3399 optional
- ※. 2GB/4GB RAM (DDR3) optional
- ※. 8GB/16GB/32GB/64GB flash optional
- ※. 4G(optional)/WLAN/WiFi network connection
- ※. 802.11 B/G/N Internal WiFi
- ※. Remote management software (CMS) optional
- ※ 1080P display output

1080P HD Media Player Box(RCS-902H)

INPUT PORTS	
USB 2.0	x2
HDMI	x1
Built in 8GB Memory	x1
ACCESSORY	
Remote Controller	x1
Power Supply	x1
User's manual&Software	x1 CD Disk
Bracket	Optional
GENERAL INFORMATION	
Working Temp	0-50 degree
Certificates	CE/FCC/ROHS
EXTENDABLE FUNCTIONS	
Motion Sensor	Optional
Color	Optional
MECHANICAL	
Power Adaptor	12VDC
Consumption	8 W
Machine Weight	0.5KG
Dimensions(mm)	218x45x140
Packaging (mm)	430x372x325
SPECIFICATION	

Video Format	MPG, MPG-1,MPG-2,MPG-4,AVI,MP4,MOV,FLV,3GP,M2TS,MKV, MKV,RMVB to1080P
Audio/Picture Format	MP3 / BMP,PNG,GIF,JPEG
Memory Cards	No memorey card need, built in 8GB Flash
Timer Function	Auto Power on/off
Auto-Copy	Auto-update content to built in 8GB Memory via USB drive
Playlist Function	Play specific file at specific time
Power Memory	Support program replaying from the setting time before the power failure
Slide Show	Support background music when playing picture
Scroll Caption	Support scrolling caption, effect index can be changed
Calendar &Time	Support check calendar,adjust time and display it on the screen on/off

Features

- ※ Support 1080P playback with HDMI output
- ※ Built in 8GB memory, no SD card need
- ※ Picture format: JPG, BMP, PNG
- ※ Video format: MP4, AVI, DAT, VOB, 3GP, MKV, MOV, FLV, MPG.
- ※ Music format: MP3, Aac, Ac3, Pcm
- ※ Language support: chinese/english
- ※ USB auto copy Function from USB to SD card
- ※ Timer, clock and playlist function

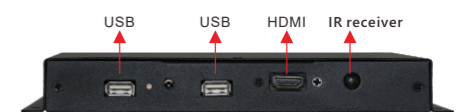



2016

⌆
 RCS-700LBM---70" Freestanding
 500nits LCD Monitor for European
 Shopping Mall since 2016



2018

RCS-550LBAZ---55" 500nits
 Freestanding LCD Display for Latin
 America Shopping Mall since 2018

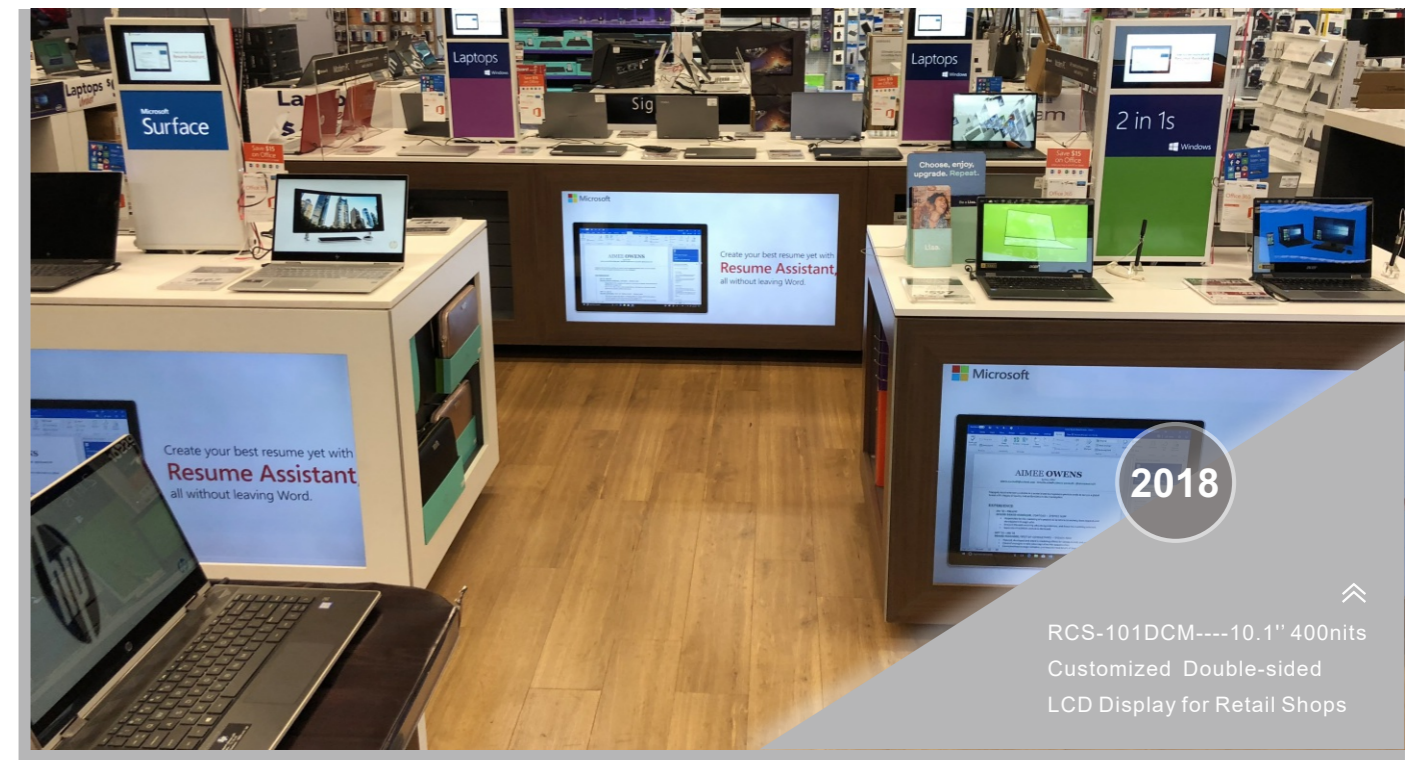

2018

⌆
 RCS-101DCM----10.1" 400nits
 Customized Double-sided
 LCD Display for Retail Shops

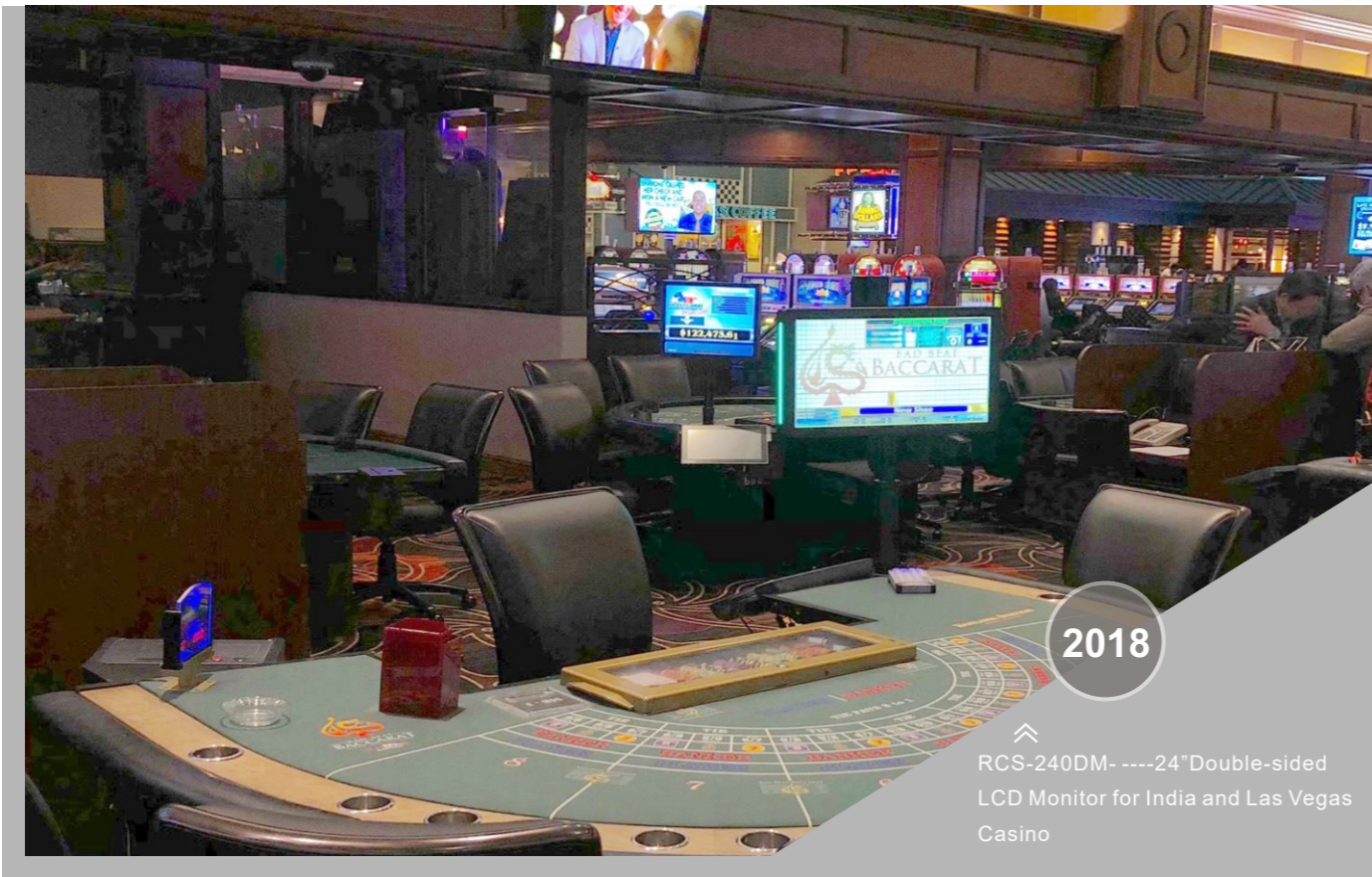

2018

⌆
RCS-240DM- ----24" Double-sided
LCD Monitor for India and Las Vegas
Casino



2014

⌆
RCS-430JBTPC-PCAP---43" Infrared
Touch Interactive Freestanding Kiosk
for Show Application



2017

⌆
RCS-430LBTPC-PCAP --43"
Capacitive Touch Digital Signage
Display for Australia Shopping Mall



2017

⌆
RCS-240CKTPC-PCAP-P ----24"
PCAP Touch All In One Display used
for Pharmacy Shop in Spain

Aging Test

100% 48 hours aging test before shipment to make sure excellent quality control.



Shipment And Package

Generally we will pack kiosk with two parts, body will be packed into carton firstly, 1pcs/ctn, then put 5pcs cartons in one wooden case to save some shipping cost.

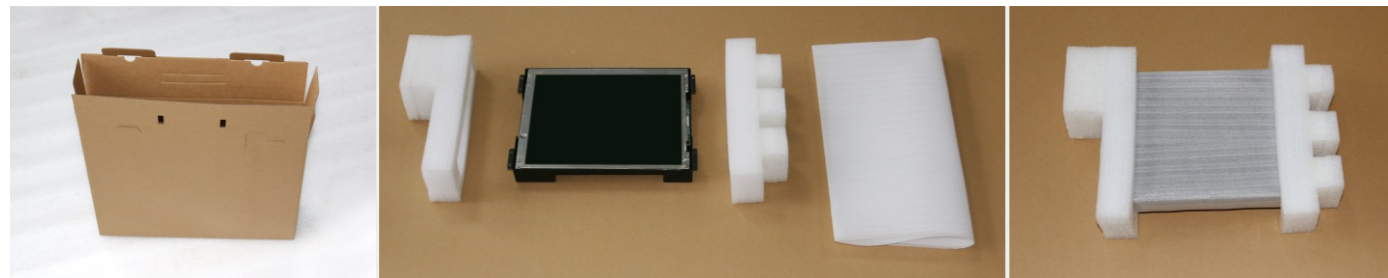
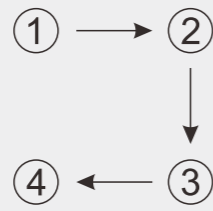

Shipment And Package

Generally we will pack kiosk with two parts, body will be packed into carton firstly, 1pcs/ctn, then put 5pcs cartons in one wooden case to save some shipping cost.

